

SOUND DEVICES



722

High Resolution Digital Audio Recorder
User Guide and Technical Information
firmware rev. 2.10



Sound Devices, LLC
300 Wengel Drive • Reedsburg, WI • USA
+1 (608) 524-0625 • fax: +1 (608) 524-0655
Toll-Free: (800) 505-0625
www.sounddevices.com



Table of Contents

Quick Start Guide	3	File Management	31
Powering the Unit		Folder Actions	
Menu Navigation Basics		File Viewer Screen	
Connecting Audio Sources		Setting/Clearing Flag Bits	
Routing Inputs to Tracks		Automatic Flag Clearing	
Recording Parameter Setup		File Time and Date	
Recording		File Size Maximum	
Playback		File Copying – Between Internal Drives	
FireWire File Transfer		File Deletion	
Front Panel Descriptions	6	False Take Control	
Panel Lock		Emptying the Trash and False Take Folders	
LCD Display Descriptions	9	Take Number Incrementing	
Left Panel Connectors and Controls	11	The file name will be altered. To remove the circle take indicate highlight the circled file as you would to circle it and select “uncircle”.	
Right Panel Connectors and Controls	12	Storage Medium – Internal Drive	36
Back Panel Descriptions	13	Formatting	
Input Setup and Control	14	Drive Repair	
Input Source Selection		Drive Type	
Analog Inputs		Drive Failure	
Input Linking (Stereo or MS Decoding)		Drive Replacement	
Signal Presence and Peak Indicator		Storage Medium – Compact Flash	38
Digital Input – AES3		When to Use CF	
Digital Input – AES3id (S/PDIF)		Formatting	
Input Delay		Testing	
Input-to-Track Routing	17	Drive Repair	
Routing		Qualified CF Cards	
Selective Input Muting		Storage Medium – External FireWire Drives	39
Sampling Rate and Bit Depth	18	When to Use External FireWire Drives	
Sampling Rate		Formatting	
Bit Depths		FireWire Bus Powering	
Word Clock	19	Qualified Drives	
Clock Slave		DVD-RAM Drives	
C. Link – Multi-Unit Linking		File Transfer – FireWire	41
Outputs – Analog and Digital	21	Powering	42
Analog Output Bus		Lithium Ion Rechargeable Battery	
Digital Output Bus		External Powering and Battery Charging	
Headphone Output	22	Time of Day Battery	
Selecting Headphone Sources		Auto Functions with External Powering	
Setting Headphone Source Options		Firmware Upgrades	44
MS Stereo Monitoring		Version Information	
Rotary Switch Behavior		Upgrade Process	
Headphone Favorite Selection		Setup Menu Presets	45
Headphone Playback Mode		Built-In Presets	
Headphone Warning Tones		Setup Menu	48
Metering and Display	24	Specifications	54
Output Meter		Connector Pin Assignments	56
Meter Ballistics		Power Consumption Variables	57
Peak LEDs		Recording Time Calculation	57
Tone Oscillator		Uncompressed Recording Time in Track-Hours	
LCD Contrast & Backlight, LED Brightness		MP3 Compressed Record Time in Hours	
Record Indication		CL-1 Remote Control and Keyboard Interface ...	59
Recording	27	Connecting the CL-1	
Recording		Keyboard Assignments	
Pre-Record Buffer		Standard keyboard shortcuts have been pre-assigned and are listed below.	
Failure During Recording		Logic Inputs and Outputs	
Playback	28	Logic Inputs	
AutoPlay		Logic Outputs	
Audio File Formats	28	Accessories	63
.WAV		Front Panel Button Shortcuts	65
iXML		Warranty and Technical Support	66
MP3 Files		CE Declaration of Conformity	67
File Naming / Numbering	29	Software License	68
Scene Name/Number			
Take Numbers			
Mono Track Name Designators			
Duplicate File Names			

Welcome

Thank you for purchasing the 722. The super-compact 722 records and plays back audio to and from its internal hard drive or Compact Flash medium, making field recording simple and fast. It writes and reads uncompressed PCM audio at 16 or 24 bits with sample rates between 32 kHz and 192 kHz. Compressed (MP3) audio playback are also supported.

The 722 implements a no-compromise audio path that includes Sound Devices' next generation microphone preamplifiers. Designed specifically for high bandwidth, high bit rate digital recording, these preamps set a new standard for frequency response linearity, low distortion performance, and low noise.

With documentary and ENG recording engineers in mind, the 722 is very small, while still being feature-rich. No other recorder on the market matches its size and feature set. In addition, its learning curve is quite short—powerful does not mean complicated. While the 722 is a very capable recorder by itself, it truly excels when used in conjunction with an outboard audio mixer such as Sound Devices' own 302 or 442.

Sound Devices took advantage of the best in professional and consumer electronics technologies to bring incredible feature depth with ease of use. Its two internal recording media (hard drive and Compact Flash) and external FireWire storage are highly reliable, industry standard, and easily obtainable. The removable, rechargeable battery is a standard Sony-compatible Li-ion camcorder cell. The 722 interconnects with Windows and Mac OS computers for convenient data transfer and backup.

Copyright Notice and Release

All rights reserved. No part of this publication may be reproduced, stored in a retrieval system, or transmitted in any form or by any means, electronic, mechanical, photocopying, recording, or otherwise, without the expressed written permission of SOUND DEVICES, LLC. SOUND DEVICES is not responsible for any use of this information.

SOUND DEVICES, LLC shall not be liable to the purchaser of this product or third parties for damages, losses, costs, or expenses incurred by purchaser or third parties as a result of: accident, misuse, or abuse of this product or unauthorized modifications, repairs, or alterations to this product, or failure to strictly comply with SOUND DEVICES, LLC's operating and installation instructions.

Microsoft Windows is registered trademarks of Microsoft Corporation. Macintosh is a registered trademark of Apple Computer. Other product and company names mentioned herein may be the trademarks of their respective owners.

The sound waves logo is a registered trademark of Sound Devices, LLC.

Quick Start Guide

The 722 is an extremely powerful and flexible portable audio recorder. Before recording, familiarity with the product is essential. Several settings should be verified or set based on individual recording needs.

Powering the Unit







1. Apply power to the unit by connecting the (included) removable, rechargeable Li-ion (lithium ion) battery to the back panel battery mount. The metal tabs on the mount line up with the electrical contacts on the battery. From the factory, the battery may not have a charge, so external DC may be needed for initial operation and charging. Connect the included AC-to-DC power adapter to the DC input plug to power and charge the removable Li-ion battery.
2. Press and hold the power key to power up the unit. To power down the unit the power button must be held for one second.

If this is the first time the recorder has been powered, or if it has been without a battery for an extended period, the date and time may need to be set.

Charge the included Li-ion battery for 6 hours prior to initial use.

Menu Navigation Basics

The setup menu provides options for recording, routing, and control parameters. The single layer menu structure allows for very quick navigation and selection of functions. To enter the setup menu press the front panel  key. Once in the setup menu, the following conventions are shared for navigating among selections and to select specific parameters.

-  - enters setup menu
- item< - highlighted menu item
-  - selects highlighted item or parameter
-  - moves up in menu and between menu parameters
-  - moves down in menu and between menu parameters
-  - exits the selected menu or menu altogether
- The  stop key will exit from any menu and cancel any changes. Use it to escape out of the setup menus.



The right panel Rotary Switch (labeled “Select”) is a convenient control to quickly navigate among menu items and item options. Its push-to-select function duplicates the check mark in most menus.

Connecting Audio Sources

1. Connect audio sources, either analog or digital, to the input connectors.
2. Set the appropriate input type and level— analog mic, analog line, or digital—with the adjacent slide switch.
3. If mic-level inputs are used on XLR 1 or XLR 2, make certain that phantom power, input limiters, and high-pass filters are activated, as required.

Routing Inputs to Tracks

Before recording, inputs **must** be assigned to tracks. Each of the 722’s two inputs can be assigned to the two tracks (A, B). Sixteen possible routing combinations are shown on the front panel with four blue LEDs. Illuminated LEDs indicate input-to-track assignment.

1. Press and hold the  STOP key then press the  INPUT key to cycle through factory routing presets. The 722 has four often-used presets for quick setup of input-to-track routing combinations. Note the routing combinations on the blue LEDs with each successive press.
2. If none of the preset routing combinations are suitable, assign a custom routing. Sequential presses of the  input key will eventually cycle to the custom routing option (see *Input to Track Routing*, pg. 18). From the custom input routing menu any input can be assigned to any track, including multiple inputs assigned to a single track.
3. Press **Exit** to leave input routing mode.

If no input is assigned to a track the 722 will not record.

Recording Parameter Setup

For most productions, the general recording parameters of sample rate, bit depth, media selection, and file format are changed infrequently. Enter the setup menu to verify recording settings. Sample rate and bit depth are displayed on the LCD panel.

1. Select the bit depth as needed.
2. Set the sample rate as needed.
3. Select the file format for recorded files.
4. Select the storage medium (internal hard drive, Compact Flash, external drive, or any combination of the three) for recording.



Recording



Now that file basics are set, you are ready to begin recording. The 722 is a record-priority box. Pressing the record key cancels all functions—except file operations—and immediately starts recording a new file. When record is pressed, the red record LED illuminates to confirm record mode. The filename in the LCD display shows the currently recorded file. Push the  stop (150 ms) key to end recording.

Playback

When recording is stopped, the most recently recorded file is immediately available for playback. Press the  key to begin file playback from the beginning of the file.

To select a file for playback:

1. Press and hold the  key to select the folder (directory) for playback, either internal hard drive or Compact Flash. The default playback directory is the volume being recorded.
2. Use the Rotary Switch, or the arrow soft-keys, to navigate through the file directory.
3. Once a file is highlighted, press the  play key to begin playback.

When playback has finished, the filename will begin flashing. Use the  fast-forward key or  rewind key to step through files in the folder, or press the  stop key to exit playback mode.

FireWire File Transfer

When connected via FireWire (IEEE-1394a) to a Mac OS or Windows OS computer (see *Specifications for computer requirements*), the internal hard drive and connected Compact Flash storage mediums are mounted onto the computer as “letter” accessible drives. Use the appropriate FireWire cable, either 6-pin to 4-pin or 6-pin to 6-pin, for interconnection. Files on the 722 can be treated as if they are local files, including renaming files, copying, and playing directly from the 722 storage medium. No drivers are required with operating systems meeting the specifications.

In general, it is good practice to copy all needed audio files from the 722 to a computer before any processing is performed on the files.

To connect the 722 for FireWire transfer:

1. Stop all playback and recording activity.
2. Make certain the 722 battery is fully charged, or connect to external DC.
3. Connect the 722 to the host computer with a FireWire cable.
4. Initiate the FireWire connection by selecting the FireWire connection option in the Setup Menu, or use the front panel keyboard sequence of the STOP key followed by the HDD (File Viewer) key.
5. The 722 will enter FireWire transfer, indicated by **COMPUTER CONNECTION** in the LCD display. All functions of the 722 are stopped while the 722 is connected to a computer through FireWire.
6. Navigate the drives on the computer and copy all needed audio files to the computer.

To avoid possible directory corruption on the hard drive, do not interrupt the connection process and always properly dismount the drives from the operating system. On Mac OS platforms, drag the drive icons to the trash. On Windows platforms, use the "Disconnect External Media" icon in the system tray.

Dismount the 722 after file transfer by "ejecting" the volume from the computer. In Mac OS, drag the disk icon from the desktop to the trash or hit ⌘-e. In Windows OS, highlight the disk icon, right-click, and select "eject". It is best practice to "eject" the 722 volume from the computer to maintain file integrity (*see FireWire File Transfer*).

Front Panel Descriptions

All settings of the 722 can be accessed and monitored through the front panel LCD and navigation keys. This allows the unit to be placed in a production bag along with field mixers and wireless transmitters and receivers.

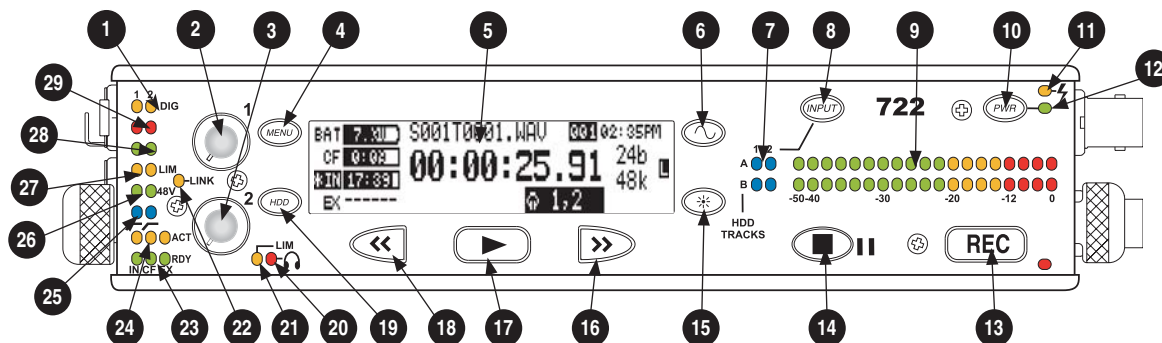

1) Digital Input LEDs

Indicates the presence of digital signal on the respective input. When flashing, indicates that digital input is selected but no valid digital clock signal is present.

2) Input 1 Gain

Controls the analog gain (input trim) of the channel 1 input. Normal mic input range is from 25 dB to 70 dB, low gain mic range is from 10 dB to 55 dB, line input range is from -6 dB to 18 dB. For line-level inputs, this control can be defeated and gain can be setup menu-controlled. If the LCD display shows "locked" when the pot is turned, gain control of the line-level input is menu-controlled. When inputs are linked as a stereo pair, Input 1 Gain controls the gain of both inputs.

3) Input 2 Gain

Controls input 2 gain, as in #2 above. When inputs are linked as a stereo pair, Input 2 Gain controls left-to-right balance.

4) MENU Key

Used to access all 722 setup menu selections. When in menu mode, used to move up through the menu selections.

5) LCD Display

Primary display of 722 status. The LCD is backlit using the LCD backlight control (#15).

6) Tone Oscillator Key

Used to activate the tone oscillator. Tone frequency, tone level, and routing are controlled in the setup menu. Press and hold to activate.

7) Input-to-Track Matrix LEDs

Blue LEDs indicate inputs (1 and 2) enabled for recording to tracks (A and B). A solid blue LED indicates an input is routed to a track. A flashing LED during "custom" routing mode shows the selected input/track combination.

8) INPUT Select Key

Pressing the INPUT key brings up the input muting and routing menu. Hold down the INPUT key and press one of the two indicated soft keys to mute inputs. Pressing the STOP key and the INPUT select key cycles through the six factory preset input-to-track routing combinations plus the custom routing menu. In the custom routing menu any input can be routed to any track. See [Input-to-Track Routing, page 18](#).

9) Level Meter LEDs

Two, 19-segment track level-meters indicate level in dBFS. Metering ballistics are selected in the setup menu.

- 10) **Power Key**
Press and hold to power up the 722.
Press and hold to power down.
- 11) **Charge LED**
Indicates the status of the onboard battery charger. Flashes when external power is connected and battery is charging; solid when battery is fully charged.
- 12) **Power LED**
Indicates that the 722 is powered and available for operation. Flashes when the removable battery or external DC is in a low-voltage state.
- 13) **Record Key**
Used to start recording. The 722 is a record-priority device, pressing this key starts recording and discontinues all other functions, except file operations. Pressing key while recording can set a cue marker or start a new file, as selected in the setup menu.
- 14) **Stop/Pause Key**
Press and hold this key for 150 ms to stop recording. In playback mode, a single press pauses playback (play-pause), allowing audio scrubbing with the FF and REW keys. Another press of the key enters play-stop mode where the FF and REW keys select files for playback from the current directory. One more press of the key exits playback mode. In the setup menu the stop key is also used to exit from any menu, returning to the main display.
- 15) **LCD Backlight Key**
Press to toggle LCD and keyboard backlighting. Hold the key and turn the Rotary Switch to adjust the brightness of LEDs. In menu mode, functions as the cancel key.
- 16) **Fast Forward Key**
Performs fast-forward (FF) scrubbing through the played file when pressed in playback and play-pause mode. Play-pause indicated by flashing A-time on LCD. Fast forward rate increases the longer the key is held. In play-stop mode (indicated by flashing filename on LCD) selects the next file in the record folder (either daily folder or main folder).
- 17) **Play Key**
Plays back the file displayed in the LCD. If pressed immediately after recording is stopped, the most recently recorded file is played back.
- 18) **Rewind Key**
Performs reverse (REW) scrubbing through the played file when pressed in playback and play-pause mode. Play-pause indicated by flashing A-time on LCD. Reverse playback rate increases the longer the key is held. In play-stop mode (indicated by flashing filename on LCD) selects the previous file in the record folder (either daily folder or main folder).
- 19) **HDD Key (File Viewer)**
Press to enter the File Viewer. Any available drive, folder, and valid audio file will appear in the file listings. Selected drive is shown in white type. Press-and-hold to toggle between available drives. If only one drive is present, press-and-hold is disabled.
- 20) **Headphone Output Peak LED**
Indicates overload of the headphone amplifier. When lit, the headphone circuit is overloading. Reduce headphone level.
- 21) **LIM LED**
Indicates that the microphone input limiters are engaged. This LED does **not** show input limiting activity (*see descriptor #27, Microphone Input Limiter LEDs*).

22) **Link LED**

Indicates that channels 1 and 2 are linked as a stereo pair. In link mode the channel 1 potentiometer controls gain, channel 2 potentiometer controls left-to-right balance. Inputs can be linked as either a stereo L/R pair or as a Mid-Side (MS) pair.

23) **Media Ready LEDs**

Indicates storage media is present and available to record; IN (internal hard drive), CF (Compact Flash), EX (external Firewire drive). Flashing indicates media problem.

24) **Media Activity LEDs**

Indicates storage media read/write activity. IN (internal hard drive), CF (Compact Flash), EX (external Firewire drive).

25) **High-Pass Filter LEDs**

Indicates that the high-pass (low-cut) filter is active for the input. High-pass only operates when the input is set to microphone level.

26) **Phantom Power LEDs**

Indicates that phantom power (48 volts) is active for the individual input. Phantom can be applied to microphone or line-level signals (menu-selected).

27) **Microphone Input Limiter LEDs**

Illuminates orange when limiting is occurring on the microphone input. If constantly lit, the microphone input is being "hit" with too high of a signal. Turn down the input sensitivity until limiting occurs infrequently.

28) **Input Signal Presence LEDs**

Indicates presence of analog or digital signal and its relative level on each of the two inputs.

29) **Input Peak (Overload) LED**

Indicates analog signal is approaching clipping (-3 dBFS) on each of the two inputs. Also used to indicate that an input is muted.

Panel Lock

Press and hold the backlight key then the tone key to bring up the front panel Button Lock Screen. Button lock prevents unintentional changing of settings or record status. The 744T will display the current mode the LCD screen.

select the soft buttons to activate the appropriate button lock mode



There are three modes:

- **Unlocked** – all buttons are accessible and operate normally.
- **Non-Transport Lock** – All front panel controls are locked except the Record, Stop, Play, Rewind and Fast Forward.
- **Lock All** – All front panel keys are locked except the Record key. The Record key is kept active so the user can initiate recording after entering this mode and enter cue markers. To stop recording in this mode, you must disengage the panel lock and hit the stop key.

LCD Display Descriptions

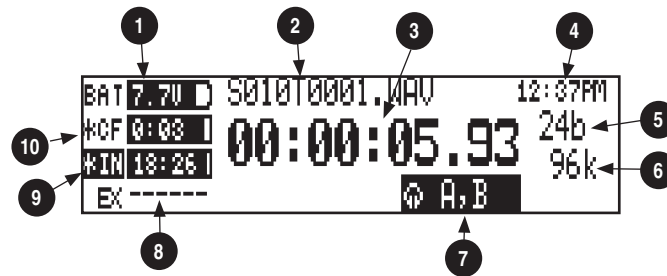

- 1) **Battery Level Indicator**
Shows the voltage level of the removable rechargeable battery or external power sources. External power overrides internal power when present. Graphical bar for relative level and numeric indicator for precise voltage measurement.
- 2) **File Name Display**
Shows file name actively being recorded or played back. In playback-stop mode, flashing file name indicates that the fast-forward and rewind keys can be used to step through files in the current playback directory.
- 3) **Absolute Time (A-time) Display**
Shows the elapsed time of the file being recorded or played back. Flashes in playback pause mode. In this mode the FF/REW keys will scrub through an open audio file. This display can be set to reverse or flash during recording. Flashes in playback-pause mode.
- 4) **Time & Date Display**
Alternating display between the set date and time of the 722. This information is written as the creation and modification date for generated audio files.
- 5) **Bit Depth Indicator**
Shows the set record bit depth. In playback, shows the file bit depth.
- 6) **Sample Rate Indicator**
Shows the set record sample rate. In playback, shows the file sample rate.
- 7) **Headphone Source Display**
Indicates the source for headphone output. Sources and selection order are user selectable in the setup menus.
- 8) **External Drive Status (space remaining/record ready)**
Bar graph indicates amount of record time remaining on the external FireWire volume. Numbers show time in hours and minutes based on the presently selected number of record tracks, sample frequency, bit rate, and file type. An asterisk next to any of the available drives indicates that it is selected as a destination for recorded audio.
- 9) **Internal Hard Drive Status (space remaining/record ready)**
Bar graph indicates amount of record time remaining on the internal hard drive. Numbers show time in hours and minutes based on the presently selected of number of record tracks, sample frequency, bit rate, and file type.
- 10) **Compact Flash Status (space remaining/record ready)**
Bar graph indicates amount of record time remaining on the Compact Flash media. Numbers show time in hours and minutes based on the presently selected number of record tracks, sample frequency, bit rate, and file type.

For all three media types, an asterisk in front of the media descriptor indicates that the media is selected for recording. Highlighted drive descriptor indicates drive selected for record monitoring, playback or file directory display.

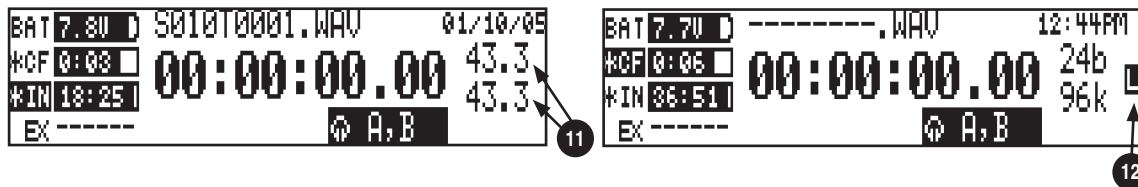

11) Input 1/2 Level

When control knobs are adjusted, indicates the gain level in dB for each analog input gain control. Top display is input 1, bottom display is input 2. Normal mic input gain range is from 26 dB to 70 dB, low gain mic range is from 10 dB to 50 dB, line input range is from -6 dB to 18 dB. "LOCKED" will be displayed on the LCD when the pot is turned with digital inputs, and with line inputs with menu control.

12) External Digital Clock Indicator

The 722 is locked to a valid external digital or word clock source when the L is in the display.

Cue Marker Display (not shown)

In record mode, indicates when cue markers are set. Markers set by pressing the record key (option must be selected in setup menu). In playback mode, displays cue points numerically as they are reached in a file.

Left Panel Connectors and Controls

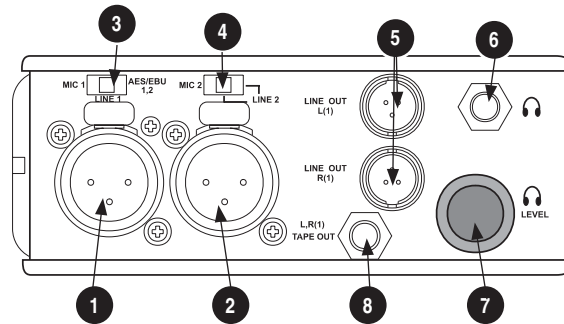

- 1) **XLR Input 1/AES3 Input 1&2**
Dual function input connection. Input type set with switch (see #3). Active-balanced analog microphone- or line-level input for input 1. Transformer-balanced two-channel AES3 input (1 and 2).
- 2) **XLR Input 2**
Same as Input 1 above for analog signals. Input type set with switch above. Active-balanced analog microphone- or line-level input for input 2.
- 3) **Mic-Line-AES3 Input Switch 1**
Selects the input level and mode of the input XLR 1 connector.
- 4) **Mic-Line Input Switch 2**
Selects the input level, mic- or line-level of input XLR 2. NOTE: there are two redundant switch positions for line-level.
- 5) **TA3 Master (L/R) Analog Outputs**
Active-balanced, line-level analog L/R outputs for the Master Analog Outputs. Program source and attenuation level are user selectable. Pin-1 ground, pin-2 (+), pin-3 (-).
- 6) **Headphone Output**
3.5 mm TRS stereo headphone connector. Can drive headphones from 8 to 1000 ohm impedances to required levels. Tip left, ring right, sleeve ground.
- 7) **Headphone Volume**
Adjusts the headphone volume. NOTE: the 722 is capable of producing ear-damaging levels in headphones.
- 8) **Tape Output**
Unbalanced tape (-10 dBV nominal) output on 3.5 mm TRS stereo connector. Signal source is identical to the Master Output Bus. Tip left, ring right, sleeve ground.

Right Panel Connectors and Controls

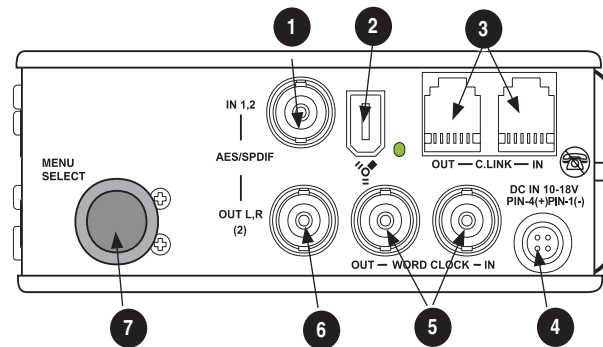

- 1) **AES3id Input**
Unbalanced digital input accepts two channel AES3 (or S/PDIF) on BNC connectors. Supports sample rates up to 200 kHz.
- 2) **FireWire (IEEE-1394) Port**
Connection to a computer to access the internal hard drive and Compact Flash volumes as mass storage devices. Direct connection to Mac OS (10.2+) and Windows (XP- and 2000-only) computers. Also functions as a FireWire host to external drives such as DVD-RAM and hard drive for direct recording to these volume types.
- 3) **C. Link In/Out Ports**
RS-232 protocol interface on 6-pin modular ("RJ-12") connector for linking multiple 7-Series recorders together. Word clock and machine transport are over C. Link.
- 4) **External DC In**
Accepts sources of 10–18 volts DC for unit powering and removable Li-ion battery charging. The Hirose 4-pin connector is wired pin-1 negative (-), pin-4 positive (+). Pin-2 (-) and pin-3 (+) are used to charge the removable Li-ion battery. DC ground at both pins-2 and 3 is at the same potential as chassis and signal ground.
- 5) **Word Clock Input and Out**
Provides clock input and output for the 722. Word input accepts sample rates between 32 kHz and 192 kHz. Word clock output is the rate that box is running. There is no sample rate conversion utility in the 722.
- 6) **AES3id Output**
Unbalanced digital output, two-channel, for Output Bus 2. Signal source is menu-selected.
- 7) **Rotary Switch**
When in the Setup Menu, the Rotary Switch moves among menu items; push to enter a selection or to enter data. In record and playback modes, rotate to select headphone monitor source; push action is user selectable.

Back Panel Descriptions

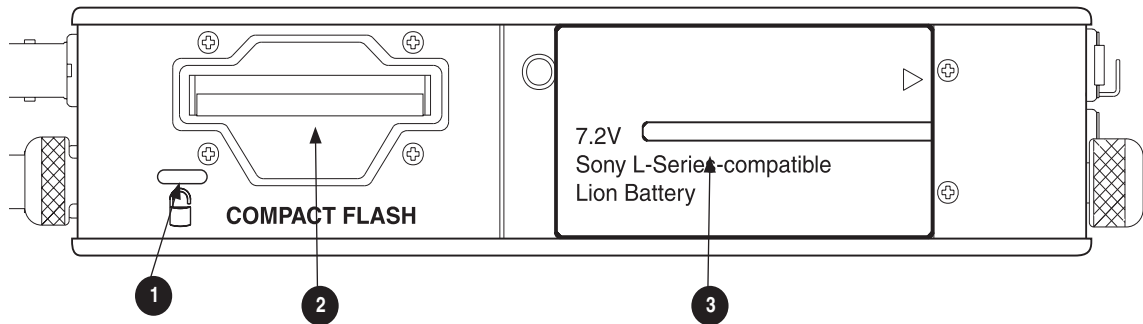

- 1) **Security Slot**
Compatible with the Kensington® Security Slot specification. Useful for securing the recorder to a fixed object with a compatible computer lock.
- 2) **Compact Flash Slot**
Accepts Compact Flash medium with the label-side up. Compatible with Type I, Type II, and MicroDrives.
- 3) **Battery Mount**
Accepts Sony® InfoLithium L- or M-Series removable rechargeable batteries, or batteries conforming to this mount. Numerous capacities, from 1500 mAh to 7000 mAh are accommodated.

Input Setup and Control

The 722 has two inputs and two record tracks. Inputs are selectable between analog or digital sources. Analog inputs are connected with the balanced XLR connectors; digital inputs can be connected to either XLR Input 1 (AES3) or the BNC input (AES3id).

Input Source Selection

Input types are selected in pairs. Each input pair accepts analog or digital audio. The XLR input signal is selected with slide switch above the connector.

Manually selecting the audio source is used to force the inputs to analog while using an AES3 or AES3id input to lock the 722 to an external sample rate.

Digital sources connected to AES3id BNC inputs override analog signals on the corresponding XLR input. The BNC input signal type is set in the menu settings **Input 1,2: Source**. For most situations the appropriate setting is auto select—the 722 will choose the input type based on signal present.

The 722 is capable of off-speed sample rates when clocked from either external digital inputs or the word clock input.

Input sources can be set to “disabled (power save)”. This option shuts down all circuitry associated with the inputs to reduce power draw and extend battery runtime during playback. When an input pair is disabled, the digital input LEDs associated with the pair will flash.

Analog Inputs

Analog inputs 1 and 2, on XLR connectors, are the primary connections into the recorder. These inputs accept balanced or unbalanced mic- or line-level inputs. When at mic-level, gain is controlled by the front panel potentiometers. Gain for the line level inputs can be controlled by the front panel potentiometers or menu settings. Line input gain is controlled in 0.1 dB steps.

A digital input present on the BNC inputs will override an analog signal present on the XLR inputs unless the input source is set to analog in the setup menu.

In the setup menu, the following functions can be controlled for analog inputs 1 and 2:

Phantom Power



Phantom power (48 volts) can be activated for inputs 1 and 2. When active, phantom is indicated by front panel LEDs (●●48v).

Phantom power is available for both mic- and line-level inputs. Using line-level inputs with microphones is useful in high SPL environments such as concert recording. Make certain to turn off phantom power with line level output devices susceptible to damage from DC.

Shortcut: To toggle phantom power without entering the menus, press and hold the tone key then press the menu key for channel 1. Channel 2 phantom can be toggled by pressing the tone key then pressing the HDD key. If the inputs are in line level mode, phantom power will not activate from the shortcut keys and must be activated from the menus. Phantom power is linked when the inputs are linked. (See [Input Linking](#))

Input Limiters (mic-level only)

Microphone inputs 1 and 2 each have a limiter circuit designed to prevent input overload. In normal operation, with proper gain settings, the limiters should rarely engage. When activated, these

limiters will prevent unusually high input signal levels from clipping the analog input stage of the preamp. The front panel LIM LED () shows that the limiter is engaged. Limiter activity is indicated by additional front panel LEDs, one for each input channel (). The input limiters are active only with mic-level inputs. The limiters are engaged by (factory) default.

When limiters are engaged, audio on channels 1 and 2 is limited to -6 dBFS.

Microphone Level Control

Microphone gain is controlled by the front panel recessed knobs. The gain control adjusts an analog gain stage and functions similarly to the input trim on a mixing console or stand-alone microphone preamplifier. Gain is controllable over two ranges, normal and low.





Gain Range (microphone-level only)

The microphone inputs operate in two gain ranges, normal and low. The normal range controls input gain from 25 dB to 70 dB of gain. The low range controls input gain from 10 dB to 55 dB. The low range is useful for high SPL recording environments.

High-Pass Filters (microphone-level only)

The high pass filters on the microphone inputs use a combination of analog and digital filters to reduce sensitivity to low frequency signals. When the high-pass is engaged on an input, its front-panel LED illuminates to indicate it is active (). The first pole of the high-pass circuit is an analog filter at 40 Hz, 6 dB per octave and is part of the microphone preamplifier circuit. Additional poles of high-pass filtering are done in DSP.

Several frequency and slope combinations are selectable, including corner frequencies of 40, 80, 160, or 240 Hz, and filter slopes of 12 dB, 18 dB, or 24 dB per octave. The high-pass is selected for each input independently.

Shortcut: The filters can be toggled with a two-key combination. Press and hold the  LCD backlight key and press the  menu key for channel 1 high-pass. Press and hold the  LCD backlight key and press the  HDD key to toggle channel 2 high-pass. The high pass filters are linked when the inputs are linked. (*See Input Linking*)

Line-Level Gain Control

When in line-level position, the gain for inputs 1 and 2 is controlled by the front panel recessed potentiometers or by a menu sensitivity setting. When set for front panel control in the user menu, **Line Input 1: Gain** and **Line Input 2: Gain** controls in the user menu are lined out and not accessible.

Input Linking (Stereo or MS Decoding)

Analog inputs 1 and 2 can be linked as a stereo pair. When linked, the channel 1 front panel potentiometer controls the signal level of both inputs, and the channel 2 pot controls the left-to-right balance of the pair. When the inputs are linked, their peak limiters are linked, as well.

When set to link as an MS pair, the inputs are decoded as MS stereo, where the gain and balance for the pair work the same as stereo linking above. Input 1 is for Mid signal, input 2 for Side signal.

When the inputs are linked, phantom power and the high pass filters also act as linked pairs. Engaging and disengaging phantom power or the high pass filters on input one will force the same function upon input two. Engaging or disengaging phantom power or the high pass filter on input two causes no effect on input one.

If MS stereo linking is selected for inputs, program sent to tracks and headphones will be L/R stereo program. To record discrete M and S signals, do not link for MS, but monitor the MS signal in headphones.

Signal Presence and Peak Indicator



The signal presence and peak indicators show audio activity before input-to-track routing. Input signal presence LED's illuminate when a -50 dBFS or greater signal is present. Input signal peak LEDs illuminate when signal levels reach -3 dBFS or greater.

Digital Input – AES3

The 722 accepts AES3 (AES/EBU) balanced digital at the input 1 XLR connector. Digital input is two-channel—AES3 signals on XLR-1 appear at inputs 1 and 2. To use the AES3 input, the input mode-select switch must be set to AES/EBU. There is no level control for AES inputs.



DIG The front panel digital input LEDs illuminate when digital signal is selected as input. If the LED is flashing, digital input is selected but a no valid digital clock is being received.

Digital Input – AES3id (S/PDIF)

The 722 accepts AES3id and S/PDIF unbalanced digital signals on the BNC connector. The 722 will auto detect the type of digital signal and adjust accordingly. Like AES3 signals, this is two channel input. There is no level control for AES3id inputs.

AES3id inputs override analog signals present at the XLR inputs. To use analog sources while using the AES3id signal as a digital clock source, select analog in the input source menu selection.

When a digital signal is present, the 722 locks its sample rate to its source frequency. This lock is indicated by a highlighted block **L** on the main LCD display to the right of the bit depth and sample rate indicators. Recording bit depth is independent of the external digital source.

When locking the 722 to an external digital signal, be certain the source is stable. Loss of digital signal will cause the 722 to revert to its internally set sample rate, even while recording. The portion of the file recorded after the loss of signal may not play back properly. Once recording has begun, unused digital inputs are muted, digital signals that appear on them after the record key has been pressed will not be recorded or affect the sample rate of the 722.

The 722 clocks itself to the first digital signal presented to it. If the 722 detects a digital signal on the BNC inputs and locks to that signal, a digital signal applied to the XLR input will be ignored until the first digital signal is removed.

Input Delay

A digital delay is selectable on each channel of the 722 in one microsecond (μ S) steps. 1,000 microseconds equals 1 millisecond (ms). The Rotary Switch and menu arrows are accelerated. The more you press or spin, the faster the delay setting will increment or decrement. Delay is not set until enter is pressed. The amount of delay available is dependent on the sampling frequency in use.

Sample Frequency	Maximum Amount of Delay Available (per input)
32, 44.1, 48, 48.048 kHz	30,000 μ S
88.2, 96, 96.096 kHz	15,000 μ S
176.4, 192 kHz	7,500 μ S

Input delay can be useful for time-aligning input signals from differing sources. For example, digital wireless mics that have a processing delay in their outputs. In addition, all digital conversion stages have delay.

Input-to-Track Routing

The 722 uses a flexible routing scheme to assign inputs and tracks for recording. The input matrix allows any input to be routed to any recording track. Multiple inputs can be routed to a single track to create mono-mixed recordings.

The 2-by-2 blue LED matrix makes it easy to view the set routing. A solid blue LED indicates an input is assigned to a record track.

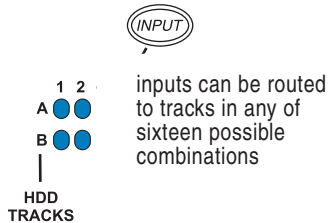

Routing

Hold down the STOP key then press the **INPUT** key to cycle through the four preset input-to-track routing combinations. These presets are factory set and cannot be changed. The last three preset selections are **CustomRoute** options. Press the **EDIT** soft key to enter the custom routing menu. Custom routing allows any input to be assigned to any record track. In the menu, highlighted input and track combination are displayed in white text. The two inputs are shown on the left; the two record tracks are shown on the right.

To assign custom input routing:

1. Press the **INPUT** key until **InputRouting** is displayed in the LCD display.

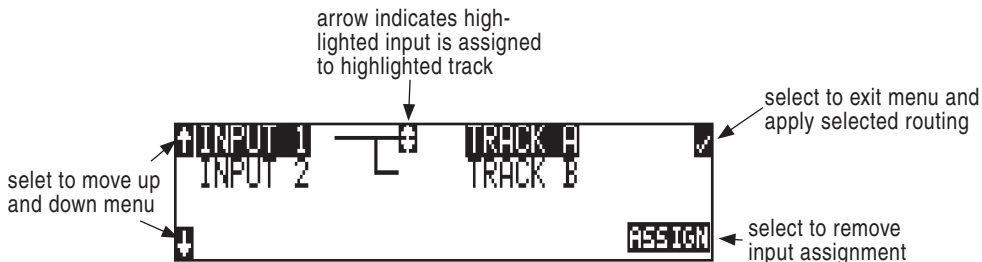

2. Press the **EDIT** soft button (**⊛**) and scroll to the appropriate input screen.
3. Using either the Rotary Switch or the up and down arrows, navigate to desired input-to-track combinations.
4. When a chosen pairing is highlighted press either the **ASSIGN** soft key or the Rotary Switch to assign the combination. Assigned tracks are noted on the screen by the addition of an arrow pointing to the record track. The LED routing matrix will also show a flashing blue LED for the currently selected input-to-track combination.
5. Once a track is assigned move to the next input-to-track combination desired.
6. To remove an input-to-track combination assignment, navigate that combination and press the **UNASSIGN** soft key.
7. Exit and complete the assignment by pressing the check mark soft key.

The input routing menu will always exit to the main screen whether entered from the input key or the menu selection.

Selective Input Muting

When the INPUT key is pressed, individual input muting is available. This feature can be used to quickly mute microphones while maintaining their respective track assignments.



A solidly lit input Peak LED indicates that an input is muted.

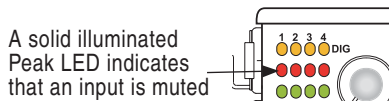

Mono- and polyphonic files behave differently when selective muting is applied. When monophonic files are selected, files from tracks A and B are named with the suffix “_1 and _2” respectively. If, for instance, track A is muted but track B is still selected, the resulting file will be named with the suffix “_2” and track A will not be recorded, saving storage space.

When polyphonic file type is selected in the same scenario as above with track A muted, the resulting data file will be a two-track file with track A being a blank track. Blank tracks in polyphonic files take up the same amount of storage space as tracks that are assigned.

Sampling Rate and Bit Depth

When recording to WAV (or BWF files) the 722 generates uncompressed, PCM audio files at the user-selected sampling rate and bit depth. The 722 LCD calculates available recording time based on the sampling rate, bit depth, number of tracks set for recording and the selected storage media available capacity. See the *Calculating Recording Time* later in this guide to estimate record time.

Sampling Rate



When a sampling rate is selected for recording, all tracks are recorded at the selected sampling rate. Sampling rates are selected among common rates from 32 kHz to 192 kHz. Additionally, non-standard sampling rates can be applied when the 722 is word clocked from an external source (clock sources between 32 kHz and 192 kHz). When recording off-speed sampling rates files will be stamped with the rate closest to an internally generated frequency.

Sampling Frequency = Available Audio Bandwidth

The sampling frequency is expressed in samples per second (in hertz) and defines the number of times in a second that the analog audio signal has been measured. Sampling frequency determines the audio bandwidth, or frequency response, that can be represented by the digital signal. A quick estimate of the maximum bandwidth capable of being represented at a given sampling rate is maximum analog frequency = sampling frequency / 2. Higher sampling frequencies allow for wider audio bandwidth.

The 722 generates the following sampling rates:

- 32 kHz
- 44.1 kHz
- 48 kHz
- 48.048 kHz
- 48.048F -file stamped at 48 kHz
- 88.2 kHz
- 96 kHz
- 96.096 kHz
- 96.096F - file stamped at 96 kHz
- 176.4 kHz
- 192 kHz

Bit Depths

The 722 records at bit depths of either 16 or 24 bit. 24 bit recording provides greater dynamic range and addition headroom for signal peaks relative to 16 bit recordings. 24 bit recording (versus 16 bit) is a significant benefit for field production audio tracks.

Bit Depth = Available Dynamic Range

Bit depth defines the digital “word length” used to represent a given sample. Bit depth correlates to the maximum dynamic range that can be represented by the digital signal. Larger bit depths accommodate more dynamic range. A quick estimate of maximum dynamic range capable of being represented by a given word length is dynamic range \approx no. of bits \times 6 dB. Bit depth is an exponential measure (exponent of 2), so as bit depth increases, the amount of data it represents increases exponentially. The majority of field recording is done with 16-bit audio, therefore, each sample is represented by a digital word of 2^{16} (65,536) possible values. 24-bit audio has a word length of 2^{24} (16.7 million) possible values per sample.

The 722 has 24 bit analog-to-digital converters. To obtain 16 bit recording the 722 can be set to dither 24 bit digital signals to 16 bit. The 722 uses a proprietary pseudo-random dither routine for accurate bit rate reduction. Dither can be defeated in the user menu. Without dither, 24 bit audio is truncated to 16 bit, meaning the least significant 8 bits are discarded.

Once a file is recorded its sampling rate and bit depth can not be changed in the recorder. The 722 does not perform sample rate conversion or bit depth changes. File conversion must be done in another environment, such as an audio workstation. Alternatively, a real-time analog transfer is often performed instead of sample rate conversion.

Word Clock

Stable word clock is fundamental to high quality a digital audio signal. The 722 uses a highly-stable crystal to generate its internal word clock frequencies. The 722 can clock external devices from its word clock and accept external clock sources for recording.

The 722 disregards external clock, both AES and word clock, during playback.

Clock Master

When sending digital audio to several devices, one unit is designated as the word clock master and the others as slaves. Generally, the device with the analog-to-digital converter is designated as the word clock master.

The 722 can function as an A/D converter and can be used as the master word clock source. Slaved devices will derive their word clock timing from either their digital audio inputs, S/PDIF or AES/EBU, or through their word clock input connection. As a word clock master the 722 generates word clock whether or not audio is sent.

Clock Slave

When using an external digital preamplifier connected to the 722 inputs, the recorder can derive its clock signal from the AES (S/PDIF) stream (it will slave to the external device), or the external device can be slaved from the 722 (if the external device has word clock input or accepts clock from the 722's digital output). If, for example, you are using a wireless receiver with a digital output, it may not have an external word clock input, and will be the word clock master.

If digital audio is connected to the 722 from more than one digital device, you must word clock the sources to the same clock, otherwise variations between the sources will render their signals unusable.

If the 722 is slaved to external word clock, be certain that the source is stable. Loss of the word clock signal during recording can cause the 722 to revert back to its internally set sampling frequency. If this occurs, the portion of the file recorded after the loss of word clock may not play back at the proper speed. For reliability, set the 722 to the same sample frequency as the word clock source. Loss of the word clock signal in this case will likely cause a glitch in the file, but the file may still be usable.

C. Link – Multi-Unit Linking

The proprietary C. Link (control link) connection allows multiple 702, 702T, 722, and 744T recorders to be connected and clocked together. C. Link also enables connection to external keyboards and switch contacts using the CL-1 Remote Control and Keyboard Interface.

When linked, 7-Series recorders have a master/slave relationship. When the master recorder enters record, the slave unit(s) will also begin recording. Multiple units can be daisy-chained together to record many tracks. The C. Link protocol links carries the following data:

- word clock
- time code information (702T and 744T only)
- RS-232 machine transport data

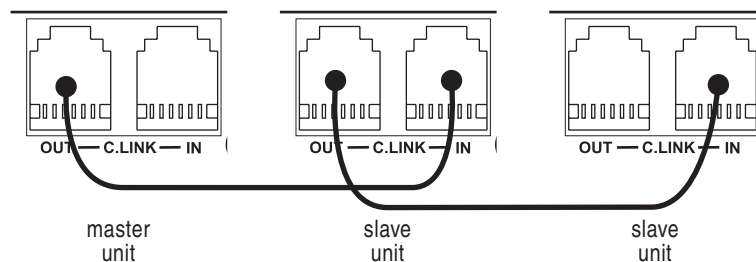

To link units:

1. Connect multiple units as shown in the illustration.
2. Set all linked recorders to the same sample rate, bit depth, file format, and time code frame rate (for 702T and 744T recorders). This will ensure that all files generated are compatible.
3. Set scene and take numbers on all linked recorders to the same starting file name. There is no file name synchronization with multiple unit linking.

When linked, record start and stop on slave units will not affect units “above” it in the linked chain. This makes it possible for units to get out of synchronization if a unit other than the master is set to record or stop. Using the master unit will assure that all machines begin and end recording together.

The C. Link jack is a proprietary RS-232 port. Under no circumstances should analog or digital telephone lines be connected to either jack. Serious damage could result.

Outputs – Analog and Digital

The 722 has two discrete output buses, the Analog Output Bus (Bus 1) and the Digital Output Bus (Bus 2). Each side (left and right) of the two-channel buses are assigned their audio sources independently, enabling the 722 to feed multiple audio devices with unique program content.

The chart below shows the audio sources available for the analog and digital output buses. The audio source for each output is selected in the setup menu.

Available Output Sources	Description
Input 1 Input 2	Inputs are assignable for each channel of the output bus. <i>When inputs are selected as the source for the outputs, the state of recording or playback activity has no effect on the output signal. This allow uninterrupted input audio at the output.</i>
Track A Track B	Track assignments and playback audio.
Input 1,2	Multiple inputs are summed with these selections.
Track A,B	Multiple track assignments are summed with these selections.

Analog Output Bus

Audio signals routed to the Analog Output Bus (Bus 1) are sent to three output connections:

- analog line out, TA3 x 2, two-channel
- analog tape out, 3.5 mm TRS, two-channel

Analog Line Out L, R

The analog line outputs are active-balanced line-level signals on Switchcraft TA3M locking connectors. The output level is a nominally 0 dBu at –20 dBFS. The level of the line output can be attenuated in the setup menu by up to 40 dB in 1 dB increments. Attenuation is done as an output pair.

Analog Tape Output

The tape output connection is stereo, unbalanced consumer output level (–10 dBV) on a TRS 3.5 mm connector. Output attenuation affects this output level.

Digital Output Bus

Just as with the Analog Output Bus, the Digital Output Bus (Bus 2) can be assigned signal sources from inputs or tracks. Sources assigned to the Digital Output Bus are exclusive and do not affect the assignments to the Analog Output Bus or headphone assignments. The same signal sources available for the Analog Output Bus are available for Digital Output Bus (see chart above).

The Digital Output Bus appears solely on the AES3id BNC output connector. The unbalanced AES3id output is directly compatible with most S/PDIF inputs.

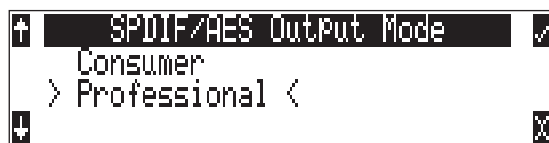

The format for the AES3id output is selectable between professional AES and SPDIF. In either case the SCMS bit is not set.

The maximum output level is 0 dBFS and can be attenuated in the setup menu in 1 dB increments by 40 dB.

Headphone Output

The 722 headphone output is a flexible tool for monitoring audio in the field. The 722 allows the user to monitor inputs, tracks, and post-record tracks in a number of combinations. MS stereo monitoring is also available in headphones.

The headphone output is independent of the Master Output Bus and the Output Bus 2—audio sources can be routed to headphones independent of routing assignments to output buses.

The 722 is capable of driving headphones to extremely high sound pressure levels. Hearing experts advise against exposure to high sound pressure levels for extended periods.

Selecting Headphone Sources

The headphone source display on the main LCD screen () shows the audio sources sent to headphones. The 722 comes from the factory with several preset headphone audio source selections available on the Rotary Switch. These selections include inputs, tracks and track monitors. Turn the Rotary Switch to select among the available headphone monitoring sources.

Track Monitoring While Recording (Confidence Monitoring)

The 722 can monitor actual recorded audio written to the internal hard drive or CompactFlash during recording. This is commonly referred to as “confidence monitoring”. To monitor recorded tracks, during recording select one of the track monitor modes. Because of the record buffering topology of the 722, a delay of up to 12 seconds can be expected before recorded audio appears at the output. The 722 will play back recorded audio from the media highlighted on the LCD panel (see [File Management and Copying](#) for more information on selecting and highlighting storage medium).

Setting Headphone Source Options

In addition to the 5 preset headphone routings, a total of 20 available “slots” can be filled in a user defined order. Headphone monitoring sources are selected from combinations of inputs, tracks, and post-record tracks, including stereo and MS decoding. The order of headphone selections is user-selectable. Available sources for headphone monitoring include:

HP Sources	Description
Inputs 1,2	Stereo monitoring of input pairs. Input 1 is assigned to left headphone output; input 2 is assigned to right headphone output.
Tracks A,B	Stereo monitoring of track pairs. Track 1 is assigned to left headphone output; track 2 is assigned to right headphone output. Upon playback, will play as track monitor.
Monitor A,B	Stereo monitoring of playback (post-record) track pairs. Track 1 is assigned to left headphone output; track 2 is assigned to right headphone output. <i>When using the recorded track monitor selection, there is a sample rate dependent delay in the signal. At 48 kHz sampling, the delay is approximately 12 seconds. This delay is due to the record buffering topology. Audio can not be monitored until it has left the record buffer and written to the recording media.</i>
Input 1, 1 Input 2, 2	Solo monitoring of selected input. This signal is sent to both sides of the headphones.
Track A, A Track B, B	Solo monitoring of selected track. This signal is sent to both sides of the headphones. Upon playback, will play as track monitor.
Monitor A, A Monitor B, B	Solo monitoring of playback (post-record) track. Highlighted media is source of monitor program. This signal is sent to both sides of the headphones. When not in playback, headphones have no program.

HP Sources	Description
Inputs 1, 2 (MS)	Stereo monitoring of discrete M (mid) and S (side) input pairs. Highlighted media is source of monitor program.
Tracks A, B (MS)	Stereo monitoring of discrete M (mid) and S (side) track pairs. Highlighted media is source of monitor program. Upon playback will function as MS track monitor.
Monitor A,B (MS)	Stereo monitoring of playback (post-record) discrete M (mid) and S (side) track pairs. Highlighted media is source of monitor program. When not in playback, headphones have no program.
Inputs 1+2, 1+2	Summed inputs appear in each ear for summed mono monitoring of both inputs.
Tracks A+B, A+B	Summed tracks appear in each ear for summed mono monitoring of both tracks.

When tracks (A or B) are monitored in headphones, audio assigned to the tracks is heard in headphones during recording. During playback the recorded track audio is heard in headphones.

To set the available headphone source options for headphone monitoring enter the **HP: Monitor** modes menu. Once you enter the Monitor Modes menu you will immediately be in slot-1. Rotate the Rotary Switch to select the source you wish to appear first in your Headphone monitor list. Once the chosen source appears, press the Rotary Switch or the soft key **ENTER** (tone) key to move to the next slot. Continue down the list to select the source for each slot in the list. Once all sources have been chosen, press (done). This will exit the headphone monitor mode setup. You can exit the selection process by pressing the stop or cancel (backlight) key at any time.

*If **DONE** is pressed in the first headphone slot, the 722 will select a single option (Tracks A, B) for headphone monitoring. The 10 factory presets will be erased.*

MS Stereo Monitoring

The MS stereo mode decodes discrete Mid-Side stereo signals to a left/right stereo signal for monitoring purposes. This allows for a proper stereo signal to be monitored in the field while discrete M and S signals are recorded for later post production. For the MS decoder to operate properly, the Mid signal is connected to input 1 and the Side signal is connected to input 2. The amount of stereo “spread” is fixed to a 50/50 percentage from Mid to Side signal.

If MS is selected for input linking, do not use MS stereo monitoring. This would result in two MS decoders being inserted in the signal path. The resulting audio in the headphones would be the discrete M and S signals!

Rotary Switch Behavior

The action of the Rotary Switch during recording and playback is set from among the three available options:

- **Disabled:** pushing the Rotary Switch has no effect.
- **Selects Favorite Mode:** places the headphone source into the mode selected in the HP Favorite menu.
- **Playback/Monitor Drive Select:** pushing the Rotary Switch toggles between CompactFlash and hard drive for playback and monitoring while recording.

Headphone Favorite Selection

If “**Selects Favorite Mode**” is selected from the choices above, pushing the Rotary Switch selects the assigned “Headphone Favorite” source. This feature is helpful to quickly return to a se-

lected headphone monitoring selection while recording or playing. One of the available headphone selection can be selected as the headphone favorite.

Headphone Playback Mode

The user may select a headphone source for automatic selection upon playback. All headphone source selections are available for Headphone Playback Mode, as well as “No Change”, which leaves the headphone source set to the currently selected mode. Headphone Playback Mode is controlled in setup menu #61.

Headphone Warning Tones

The 722 can generate an audible beep, or warning “bell”, in the headphones when an error has occurred. The specific error will be reported on the LCD. The output level of the warning bell is menu-selectable from off to -12 dBFS in the setup menu.

Recording Start and Stop Tones

If activated from the setup menu the start of recording can be indicated audibly by a single, 440 Hz tone sent solely to headphones. When recording is stopped, two 220 Hz tones play in headphones.

Low Battery Warning

When either the attached battery or external power supply voltage reaches their low warning levels (6.5 V for the attached Li-ion, 11.0 V or user-selectable for external) warning tones are played in headphones. The warning tone is a three pop note of 880 Hz every 20 seconds.

If all warning tones are turned off, no tones are sent to headphones, including low battery warning tones.

Metering and Display

The 722 features a 38-segment LED (2 x 19) signal level meter. The DSP-controlled meter provides a selection of ballistics and lighting intensities. In addition, peak indicators on input channels show overload activity.

Output Meter

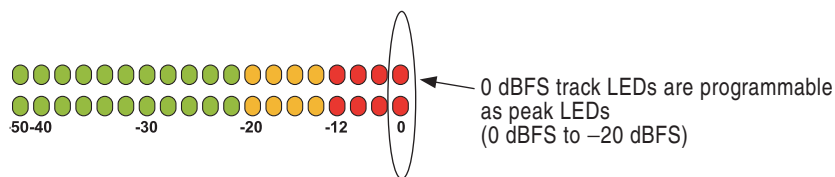

The meter uses energy efficient LEDs viewable in full sunlight. The 722 output meter is unaffected by shock or extremes in temperature and humidity. Meter ballistics are setup menu selectable among VU, Peak, Peak-Hold, VU + Peak and VU + PeakHold.

The meter uses a compound metering scale which increases meter resolution in the most important part of the scale. From -50 to -40 dBFS, each LED segment equals approximately 10 dB. From -40 to -12 dBFS, each segment equals 2 dB. From -12 to 0 dBFS each segment equals 4 dB.

Meter Ballistics

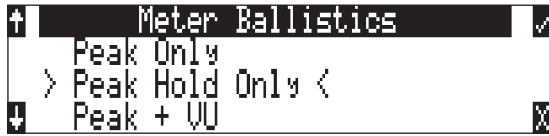

The output meter can be set to display any of five types of meter ballistics: VU, Peak, Peak-hold, a combination of VU and Peak, and a combination of VU with Peak-hold. The meter ballistics are selected in the setup menu.

VU - (Volume Units)

Ballistics correspond closely to how the human ear perceives loudness and provides a good visual indication of how loud a signal will be. In VU mode, the attack and decay of the meter signal is 300 mS. While giving a very good visual indication of perceived loudness, VU meters gives poor information on actual signal peaks and are virtually useless for tracking to the 722. In VU mode, the front panel meter labeling is in volume units.

Peak

Peak-reading ballistics correspond to actual signal maximums, but don't necessarily correspond to perceived signal loudness. A peak meter has a near-instantaneous attack to display maximum signal amplitude and a slow decay to allow the user to see them. Peak metering is essential for digital recording, since signal overload can cause immediate distortion. The peak meters front panel markings are calibrated in dBFS, decibels relative to full-scale digital signal.

Peak Hold

Essentially the same as Peak metering where the peak level indication will hold for the peak level indication for several seconds. Peak-hold indicators are useful for metering in applications when an overload condition is unacceptable.

Peak/VU

The meter can simultaneously display VU and Peak level information. In this mode the perceived loudness (VU) is displayed on a bar graph, and the Peak signal on a dot above the VU. With this combination the user gets the best of both VU and Peak metering by seeing both the "loudness" of the signal and the peaks at the same time. Peak/VU is the factory default.

Peak Hold/VU

Similar to VU/Peak mode, this mode holds the peak level indication for several seconds before releasing. Peak Hold indicators are useful for metering in applications when an overload condition is unacceptable.

Peak LEDs

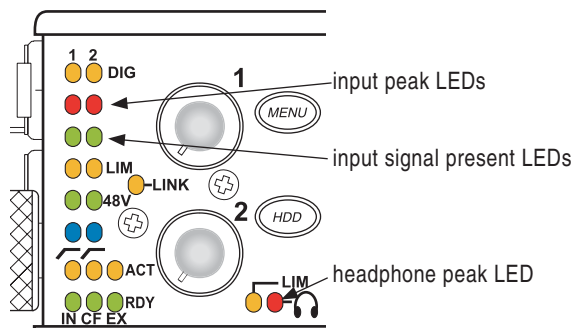

In addition to the main LED output meter, peak LEDs show input peaks, track peaks, and headphone peaks.

Input Peak

The 722 has a peak LED associated with each input. These LEDs illuminate when input signal reaches -3 dBFS. There is no user-adjustment to the Input Peak LEDs. These LEDs also function as indicators of input mute activity (see *Input-to-Track Routing*).

Track Peak

The 0 dBFS LED on each track can also function as a track peak indicator. The user can select a signal threshold above which the 0 dB LED will flash.

Headphone Peak

Like the channel peak LEDs, the headphone circuit has an indicator for peak overload. This LED is useful, since headphones can often overload before the recorder overloads. Monitoring without a visual indication of headphone clipping may mislead the operator into thinking that the output or return tracks are distorting.

Tone Oscillator

The tone oscillator level and frequency are user selectable. Tone level is adjustable over a range of -40 to 0 dBFS. Tone frequency is adjustable from 100 to 10,000 Hz. Standard tone levels vary according to the practices and needs of production and post-production, but are generally in the -20 to -12 dBFS range.

The tone oscillator is activated by pressing the front panel  key. Tone will active only while the tone key is pressed. Tone is routed where specified in the setup menu. Routing choices include: outputs, outputs and tracks, tracks only, or no tone routing (disabled). Tone can only be recorded to the head of an audio file. To record tone, press the tone key and continue to hold it down while starting to record. Subsequent presses of the tone key are locked out to prevent tone from inadvertently being recorded.

LCD Contrast & Backlight, LED Brightness

LCD contrast is setup menu controlled. From the factory the contrast is set to 50%, suitable for most viewing conditions. Contrast can be increased or decreased.

The front panel  key toggles the LCD and key backlight. Backlighting is suitable in low or no ambient light situations.

LED brightness is continuously adjustable from low to high. Hold down the  key, then turn the Rotary Controller to change brightness levels. The brightness of all LEDs is adjusted. In stealth mode (setup menu selected) the LEDs are toggled on and off with the LCD backlight key.

Record Indication

The position of the A-time numbers and time code numbers can be exchanged in the setup menu. When **Big time code** is selected in the menu the time code is displayed in the main numeric display. If time code is turned off A-time is shown as large numbers, even with **Big time code** set.

To provide for additional visual indication that recording is in process the big numerals can be set to reverse contrast or to flash during record. This is menu-selected.

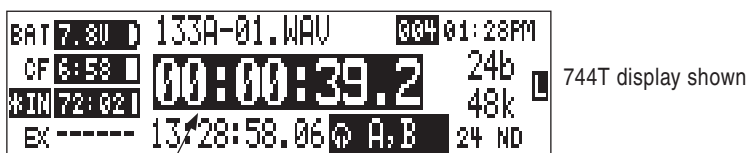

reversed numbers indicating that recording is active

Recording

The user interface of the product has been designed similar to a “tape recorder”. Recording and playback functions are quite similar to that of tape-based machines. The flexibility of file-based recording provides control not possible with tape-based recorders.

Recording



● The largest, most easily accessed control on the 722 is the record key. Recording takes priority over all activity except for disk formatting, disk speed tests, and file transfers. The 722 will immediately enter record mode whenever the record key is pressed. When recording, the adjacent red LED will illuminate to indicate that the unit is in record mode.

If no inputs are routed to tracks or if no medium is selected for recording, recording cannot take place. Make certain that at least one record track is assigned for recording.

While recording, the power, ff, rew, input, tone, and drive keys are disabled. Recording is stopped by pressing and holding the STOP key. The Stop key must be held for 150 ms or greater to end recording. Although the setup menu can be viewed during recording, menu items affecting recording are lined out in the menu list.

During recording, subsequent presses of the record key can perform one of three setup-menu-selected actions:

- no action,
- new cue - cue markers are set within the file being written,
- new file - a new file is started with each press of the record key, the take counter is increased by one.

When removing the CF from the 722, always observe the amber CF activity LED. If it is lit, wait until it goes out before removing the CF. If you remove the CF while the LED is lit, the file will be corrupted and there is a possibility of FAT corruption as well.

Pre-Record Buffer

To prevent missing record cues or up-cutting takes the 722 has an available pre-record (or pre-roll) buffer. When active, pre-record begins recording at a set number of seconds PRECEEDING the record key being pressed. The amount of pre-record is sample-rate-dependent. At 48 kHz, ten seconds of buffered audio is available. At a 96 kHz sampling rate five seconds is available. At very high rates (192 kHz) two seconds of pre-record buffer is available.

Failure During Recording

In the event of a recording media failure the error will be indicated on the front panel and by a tone in headphones. Possible causes of media failure include a hard drive is in severe motion which results in recording errors, or a the Compact Flash card filling up while recording. If both hard drive and CF are selected for recording, recording will continue on the medium without the failure.

Front Panel Lockout

See *Panel Lock* on page 8 to engage panel lock during recording.

Playback

The 722 has high-resolution playback circuitry and is appropriate for any reference audio application. Any file recorded by the 722 can be played back. MP3 file playback is available, as well. In addition, files copied to the storage medium from a computer can be played back. This is useful when using the 722 as a high-resolution playback device.

The 722 plays back the last recorded audio file unless another file is selected. There are two ways to select another file for playback. To select another file in the current record directory, push either the FastForward or reverse key to put the 722 in to play-stop mode. The filename display will begin flashing and the FastForward and Reverse keys are used to step through files available in the current record directory. To select a file in an alternate directory, press enter the File Viewer by pressing the HDD key. Navigate to the appropriate folder on any available storage drive. Select the file to play back with the Rotary Switch and press play.

AutoPlay

The 722 can be set to play back all (playable) audio files in a folder. Files will play back in their order in the folder. Autoplay can be set with the following options:

- **Disabled** – auto playback is off
- **Play all** – all files in the directory will play, then stop when all files have been played
- **Repeat one** – the selected file will play back, then continue until
- **Repeat all** – all files in the directory will play in succession, then repeat until stopped by the user

Audio File Formats

The 722 records audio to the industry-standard Broadcast Wave file format, either monophonic or polyphonic. All files created by the 722 receive the .WAV file extension. The 722 will read files with the .BWF extension.

.WAV

The 722 writes AES-31 BWF-formatted files. The audio files created by the 722 place additional information in the file header, called the Broadcast Audio Extension data chunk. Software that does not recognize this additional broadcast wave data chunk will simply ignore this added information. Among the values recorded are:

- date and time of the original recording
- bit depth
- sampling rate
- originating machine serial number

iXML

The 722 includes iXML (revision 1.5) data in addition to the broadcast wave extension data. For iXML-aware software applications this data is available. For applications that don't recognize iXML, this information is ignored.

Notes

iXML supports notes fields. From the File Viewer select OPTIONS, then Notes.



Using an external keyboard via the CL-1 Remote Control and Keyboard Interface the entry of notes is much quicker than using the Rotary Switch.



MP3 Files

The 722 can play back MPEG-1 Layer III (MP3) audio files. The 722 has a high-quality MP3 decoder that can play back both fixed-rate and variable bit rate MP3 files with 44.1 or 48 kHz sampling rates. Additionally, the 722 can play back MPEG-1 Layer II audio files with an .MP2 extension. The Absolute Time (A-Time) of the file will appear in the file viewer and during playback on the front panel. MP3 playback is very useful on-set to play a personal MP3 audio library during leisure time.

File Naming / Numbering

Files generated by the 722 are named using a syntax made up of four parts: scene number, take number, mono track designator (if mono file is selected), and extension.

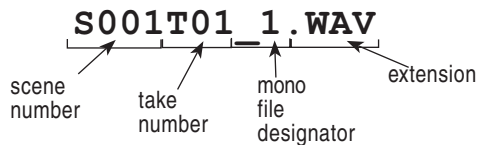

Scene Name/Number

Scene names are made with alphanumeric characters, including “_” and “-” can be any length between zero (0) and nine (9) characters in length. Scene numbers are helpful to match audio with the corresponding scene in a production. Scene names can also be used to identify other items, including recording date, artist name, or any other descriptor as required.

Scene names are user-selected in the setup menu and do not change until changed by the user.



To change scene numbers:

1. Enter the user menu and navigate to the Scene Name/Number option.
2. Use the REW (<<) and FF (>>) soft keys to move among characters. Use the PLAY key to delete characters. Characters are entered from left to right and deleted from right to left.

3. Use the Rotary Switch or the soft key arrows to choose characters. Press the Controller or hit the fast-forward key to save the character and move to the next position.
4. To save the scene name, press the soft check key or the Controller without selecting a character. After the ninth character is entered, the scene name is automatically saved.

If all characters are removed, no scene name will be written to files. If Scene Folder is selected for file management, all takes will be placed in the root of the drive.

Take Numbers

Take numbers are integers between **01** and **32000**, with or without preceding zeros, which increase by one each time a new file is recorded. Take numbers can be set with or without a take separator, such as the character “-” or “T”. Take numbers can be overridden and a new take number can be set in the setup menu. If the 722 detects a file with a duplicate name in the destination folder, a letter suffix, starting with “A” is added to the file name, before the extension. Note that take number handling can be selected to reset if set in the setup menu (see *File Management and Copying*).

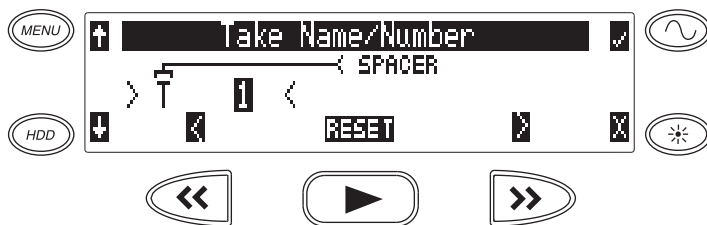

To change take numbers:

1. Enter the user menu and navigate to the Take Name/Number option.
2. Use the REW (<) and FF (>) soft keys to move among decimal places and to jump to the single alphanumeric take spacer character. Use the PLAY key to reset the take number to 1. Characters are entered from left to right and deleted from right to left.
3. The Rotary Switch or the soft keys are used to choose characters/numbers. Press the Controller or hit the soft check key to save the character and move to the next position.

From the user menu the action for take resetting is controlled from the following options:

- **Never** – take numbers do not reset
- **When scene is changed** – take resets when scene name is changed
- **When daily folder is changed** – takes reset on new day
- **Either scene or daily**– takes reset on either change

Mono Track Name Designators

When recording monophonic WAV files each track is recorded in a separate data file. To identify each track, each file is identified by an underscore and track number suffix. The file of the first track recorded has “_1” appended to it. Numbers don’t necessarily correspond to specific tracks, only to the number of tracks recorded. For instance, if track B is the only track recorded, it’s designator will still be _1.

Duplicate File Names

When the 722 detects that a duplicate file name is going to be generated in any specific folder, the 722 changes the file name by adding of a letter suffix before the extension. For instance, if take numbers are reset but files are recorded to the same folder as previous files, a suffix “A” is added to the file. If additional duplicate files are generated the letter suffix increments, to B, C, etc.

File Management

The 722, like a computer, saves audio recordings to a file system containing files and folders. The 722 formats its internal hard drive, Compact Flash medium, and attached external drives as single drives named “722 INDD”, “722 CF”, and “722 EXTHDD,” respectively. All files generated by the 722 can be saved to the Root Folder, a Daily Folder, or a Scene Folder.

Folder Actions

Files generated by the 722 are placed in the root 722 folder, a “daily” sub-folder, or a Scene sub-folder. File folder action is set in the Setup menu under the selection **File: Folder Options**. Folder choices include **Top-Level**, **Mid-Level**, and **Bottom Level folders**.

- **Top-Level folder** - is a root-level folder and can be set with a user-selected name. The Top-Level folder can also be de-activated by selecting <None> from the Setup Menu. If the Top-Level folder is not used then the next lower-level folder will reside at the drive’s root. If the **Top-Level** folder is active then the **Mid-Level** and **Bottom-Level** folders will be its sub-folders.
- **Mid-Level /Daily folder** - can be selected as a <Daily> folder, a folder with a user-selected name, or not used. If a **Top-Level** folder is in use, the **Mid-Level** folder will be a sub-folder of the **Top-Level** folder. If no **Top-Level** folder is used the **Mid-Level** folder will reside at the drive’s root. If set to <Daily> a new folder will be created daily. When recording past midnight the 722 will prompt to make to a new daily folder.
- **Bottom-Level /Scene Folders** - can be selected as a <Scene> folder which will use the name generated from **Rec: Scene Name/Number** Setup Menu, as a user-selected name, or not used at all. If no upper-level folder is in use, the **Bottom-Level** folder will reside at drive’s root. If the **Mid-Level** and/or **Top-Level** are in use the **Bottom-Level** folder will be a sub-folder.

Example: If a daily Folder is desired, set the **Top-Level** to <None>, the **Mid-Level** folder to <Daily>, and the **Bottom-Level** to <None>. This will generate a Daily Folder in the root directory with it’s files directly inside the folder.

A hierarchical view of files generated by the 722 is below.

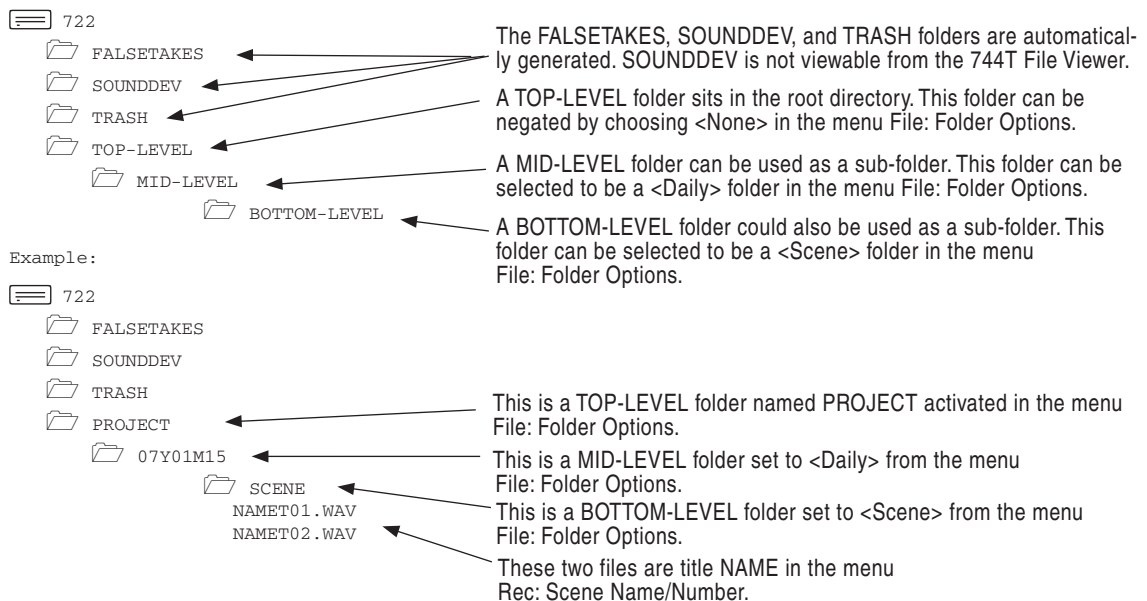

File Viewer Navigation

Moving from file to file is similar to navigating among files on a computer.

1. Enter the file menu by either selecting **File:ViewFiles** file in the setup menu or by pressing the front panel HDD key. By default the current record folder is opened.
2. To move up the hierarchy scroll up to the top of the menu to “\..”.
3. Press enter or the Rotary Switch button to go up one menu level.
4. From the root menu, selecting \.. opens the media select screen.
5. Continuing up the file hierarchy the media menu is viewable. Select either internal hard drive or CF (if installed) and drill down through the directories of that medium to the file required.



Larger files take added time to show details; this is normal.

File Viewer Screen

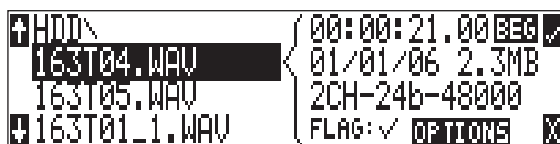

The file list screen contains information about the individual audio files contained in the folder. The left side of the display shows files and folders. The top line displays the folder path in the form of **media\folder name**. File names are listed in the order they were recorded.

Data files not native to the 722 will not show in the File Viewer, although folders that they occupy will be visible.

File detail is shown at the right side of the display. The center divider points to the file selected for information viewing. Information shown includes:

- file creation date, file archive bit status, checked means the file archive bit is set, clear means the file archive bit is cleared
- file creation time, file size
- number of tracks, bit depth, sample rate
- The length (**LEN**) of the file

The file directories always exit to the main screen whether entered via the menus or the HDD key.

Setting/Clearing Flag Bits

Pressing the tone key in the File Viewer display opens the “**Set or Clear Flag Bit**” screen. The options for setting or clearing flag bits include: set or clear the selected file, set or clear all the files in the current folder, or set or clear all files on the volume.

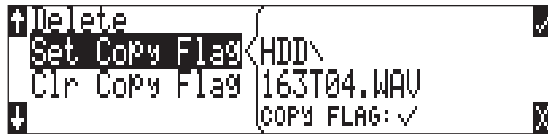

All files created by the 722 have their archive bit set to on.

Automatic Flag Clearing

The 722 can be set to clear the flag bit of copied files automatically. When enabled in the **File: Copy Flag Reset** menu, all files copied internally by the 722, but not via FireWire, will have their flag bits cleared on the original file.

File Time and Date

Similar to a computer file system, all files recorded by the 722 are stamped with the time and date of file generation. To ensure that accurate time-of-day and file generation dates are written for each file, make certain that the time-of-day clock and calendar are accurately set.

1. Enter the **TIME/DATE: Set** menu.
2. Set the current time and date using the navigation below.



Once set, the time and date clock will be kept while the removable rechargeable battery is attached. If it is removed the internal AA NiMH time-of-day battery maintains the date for up to 5 days.

File Size Maximum

The 722 data volumes (internal hard drive and CF) are formatted and write to FAT32 file structures. This structure allows these drives to directly mount in a wide variety of computer platforms, including Windows, Mac OS, and Linux. Using the FireWire connection both internal drives (internal hard drive and CF) appear as external FAT32 volumes.

Windows XP has a limitation on FAT32 drive formatting; XP can format a FAT32 volume to a maximum of 32 GB, however it can read FAT32 volumes as large as 2 TB.

FAT32 has a maximum file size limitation of 4 GB. While it is possible to have thousands of files on the 722 medium(s), the largest any single file may be is 4 GB. The 722 automatically splits an audio file before the 4 GB size is reached and begins writing to a new file. When joined in an editing program, these files match seamlessly with no samples lost. The 722 has menu-selectable file size maximums of 650 MB, 1 GB, 2 GB, and 4 GB. The 650 MB size allows the user to break an audio program into CD-R sized files for backup to inexpensive CD-R medium.

File Copying – Between Internal Drives

Audio files are easily transferred between CF and the 722's hard drive. File transfer is initiated with the setup menu option **File: Copy File**.

The Copy File menu has four options for each media type:

Copy All [Media] > [Media]:

Copies all files from one media to the other.

Last 24Hr [Media] > [Media]:

Copies files created in the last 24 hours between media.

Last 48Hr [Media] > [Media]:

Copies files created in the last 48 hours between media.

Flagged [Media] > [Media]:

Copies all files with their archive bit set between.

Once file copying has begun, the 722 searches the source media for the selected files. The 722 will then search the destination drive looking for duplicate file names. The LCD will report the number of files found, the number of duplicates found and the net number of files to be copied and prompt to continue.

Pressing the enter key or controller button begins copying. The LCD will report progress of the file being copied and the number of files remaining to be copied. When file copy is complete, the 722 will report the number of files successfully copied and show a progress bar showing the percentage of files successfully copied.

Error Conditions:

If a file is too large for the destination medium, the 722 will give you the option to skip it or cancel copying. If an error occurs during file copying, the 722 will prompt to cancel the transfer. When the destination medium is full, the 722 will report the error and end the transfer.

File Deletion

Any file or folder on either internal hard drive or Compact Flash can be deleted. Permanently deleting files is a two-step process. Similar to Mac OS and Windows operating systems, the 7-Series uses a “trash” folder to temporarily hold files which have been deleted. To send a file to the trash, perform the following:

1. Press the  HDD button to enter the File Viewer.
2. Navigate to the file to be deleted.
3. Press the soft key marked **OPTIONS**.
4. Select **DELETE**.
5. You will be prompted to verify file deletion.

The file has now been moved to the trash folder and will no longer appear in the file listing. It will, however, appear in the trash folder. Files sent to the trash folder can be viewed and played.

If a file or folder has accidentally been sent to the trash the drive can be mounted to a computer via FireWire and moved back to its original folder. Files and folders moved to the trash cannot be removed from the trash from the 7-Series recorder.

False Take Control

To identify a take as a false take, perform the following:

1. Press stop  to end recording.
2. Hold down the stop key and press rewind to be prompted to delete the most recent take.
3. Press the soft check box to delete the take.

Files that have been deleted as false takes are moved to the **FALSETAKES** folder. This folder sits in the drive root. For 722 and 744T users recording to internal hard drive and Compact Flash, files from both media will be moved to each media's **FALSETAKES** folder.

False takes will remain on the drive until the **FALSETAKES** folder is deleted (see Emptying the Trash and False Take Folders above).

Emptying the Trash and False Take Folders

Files that have been moved to the trash and false take folders (see below) can be permanently deleted from the recorder. Each drive has its own Trash and False Take folders and they are permanently deleted independently.

Once the trash and False Take folders have been emptied, any files or folders they contain are permanently deleted and cannot be recovered.



Take Number Incrementing

To advance to a higher take number hold the STOP button and press FastForward. The file name to be recorded is indicated above the file time.

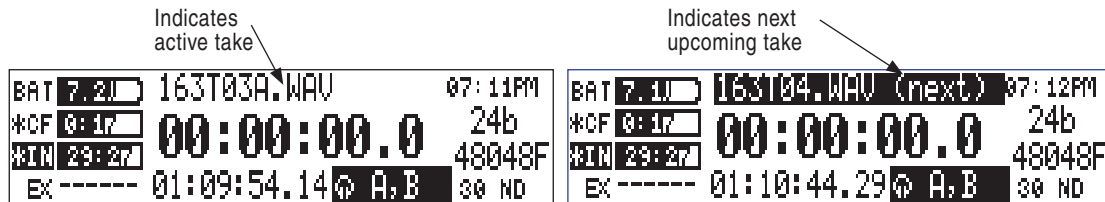

Take List

The take list shows a sequential listing of the last 200 recorded file, without regard to what folder they have been recorded in. The first file in the list, marked with an * indicates the file name of the next recorded take. Subsequent takes are listed in the order of recording from the 7-Series. Only files recorded on the unit will appear in the take list, unlike in the File Viewer, where all valid sound files are shown.

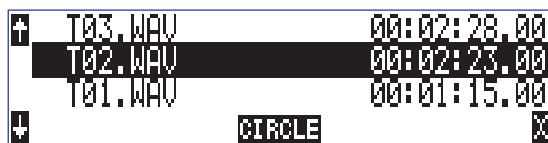

From the take list several controls are available. Take Number Incrementing is available, as well as False Take deletion. Soft keys move among take numbers.

Circle Take

Take names can be altered to include the "@" symbol preceding the file name. This can be used to highlight a take as a "circle take". Circle takes are often used to identify good takes for transferring.

To identify a circle take, perform the following steps:

1. Press stop to end recording.

2. Hold the stop button down, then press PLAY to enter the Take List
3. Scroll among files to highlight the file as a circle take.
4. Hit the circle take soft button (play).

The file name will be altered. To remove the circle take indicate highlight the circled file as you would to circle it and select “uncircle”.

Storage Medium – Internal Drive

The 722’s internal hard disk drive is the 722’s primary storage medium. The large capacity and fast data read/write speeds of hard drives are a perfect choice when long length, high data rate recording is performed. Hard drives are a good balance of speed, reliability, noise performance, and current draw. Higher speed hard drives can be used with the 722, however, they will not significantly improve performance. High speed drives slightly increase transfer throughput with the penalty of increased power draw (reduced battery run time).

Formatting

The drive installed in the 722 is formatted at the factory as a single-partition FAT32 volume. If a drive with multiple partitions is installed, the 722 will only “see” the primary partition. The 722 can only address one partition.

As a matter of routine maintenance, periodic re-formatting of the 722 hard drive is recommended. Formatting the hard drive rebuilds the FAT (file allocation table) and erases any audio or other data files present on the medium. This reduces possibility of corruption and reduces the possibility of fragmented audio files.

Be certain that all files on the 722 drive have been backed up to another media before formatting. Once formatted, all data on the drive will be erased.

To format the 722 internal hard drive:

1. Verify that all data on the hard drive has been copied or is no longer needed.
2. Press the Menu key.
3. Use the Rotary Switch to scroll to **InHDD: (Erase)**.
4. Press the controller button to begin formatting.
5. Press the controller once more to confirm the operation.

Formatting the 722 hard drive can take up to 30 seconds. When the format is completed, the 722 will create a fresh menu hierarchy, including the daily folder, if selected. Once you exit back to the main screen the 722 is ready for recording.

Drive Repair

Included in the on board software for the 722 is a basic drive repair utility. The utility is similar to Windows “Scandisk” and will check for file system integrity, recover lost cluster-chains, fix or recover damaged file allocation tables (FAT), and repair corrupted WAV files. This utility should be run after improper media removal, or in the event of a write error during recording.

When selected from the setup menu, the repair utility will scan the drive for problems, report the number of errors and correct the errors.

Drive Type

The 722 ships with a 2.5-inch ATA-5 interface, 5400 RPM hard drive. Sound Devices has chosen the specific mechanism for maximum vibration and shock resistance. Most 2.5 inch drives conforming to the ATA specification can be substituted for the factory hard drive. When choosing a replacement hard drive, note that higher RPM hard drives draw more current, reducing battery run time.

Drive Failure

Hard disk drives are mechanical devices and are susceptible to damage from physical shock. One type of physical shock, called **operating shock**, occurs when the disk is in operation. During operation, the drive head is typically over the drive platters reading or writing data. When a physical shock to the drive occurs during operation, the head and the platters can come into contact causing both components to be damaged. The second type of shock, called **non-operating shock**, occurs when the head is in the unloaded position, or not positioned over the platters. When a physical shock occurs in the non-operating state, the head can contact the ramp it is positioned over and damage the ability of the head to read and write data to the hard disk drive. All devices with hard drives are subject to damage from operating and non-operating shock.

The mechanical construction of the 722 is designed to minimize the transmission of shock to the hard drive. The drive is isolated from the chassis using special shock-reducing closed-cell foam. This material increases the amount of shock the hard drive can withstand. Additional protection can be achieved by operating the unit in a carry case.

If the recorder is used in applications subject to extreme motion, Sound Devices recommends recording to CF medium only. The hard drive will park its write heads to reduce the chance of failure.

Like all electrical devices, the higher the ambient temperature the shorter the drive's operational life. Therefore, take care to observe the specified temperature rating.

There is also a risk from sudden temperature changes, which can create condensation inside the drive. This condensation can lead to the drive's read/write heads adhering to the disk surfaces which will, in turn, stop the hard disk from rotating. Condensation tends to occur when the temperature inside the drive suddenly falls, for example, just after the unit is moved to a new position, or after operation is stopped in a cold environment.

Sudden changes in temperature or air pressure can cause disk surface material to evaporate, which can also cause the head to adhere to the disk surface. This can happen when a hard disk drive is left unused for a long period of time.

Drive Replacement

The internal hard drive can be removed and replaced if the drive fails or if a different capacity drive is needed. The internal hard drive is not a swappable medium. Its multi-pin connector is not rated for repeated insertion and removal cycles and may be prone to breakage with repeated cycling.

In typical service conditions Sound Devices recommends hard drive replacement every three years.

The hard drive is mounted to the bottom-side of the recorder's chassis and is screwdriver accessible. The drive is "suspended" in the unit with a shock isolating membrane and is attached to the main circuit board via a "flex board". Since the unit's high-density circuitry and tight construction require specific electronics knowledge, Sound Devices strongly recommends drive replacement be performed by a qualified technician using proper ESD precautions. Drive replacement done by a qualified technician has no warranty implications.

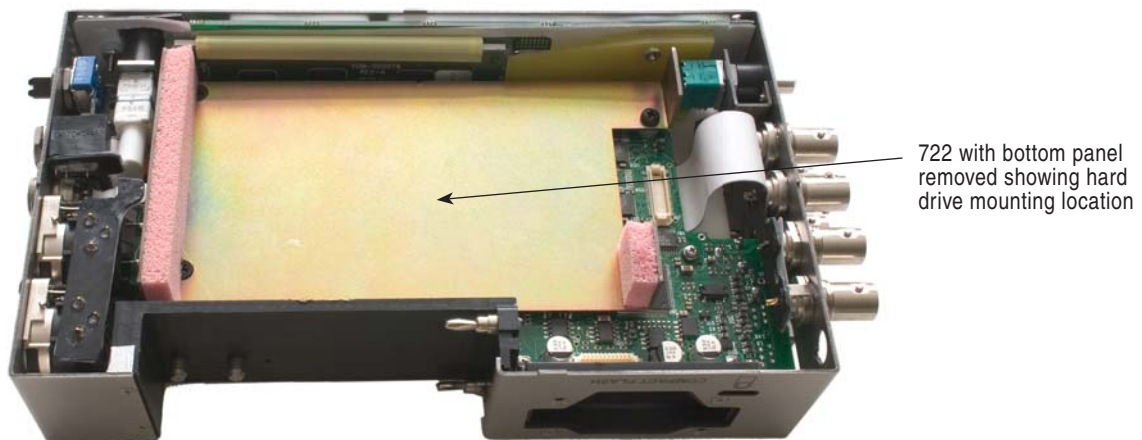

The internal hard drive is not intended as a swappable exchange medium. Only qualified service technician using proper ESD precautions should perform drive replacement.

Storage Medium – Compact Flash

Compact Flash (CF) is a practical, portable storage medium for audio recording. Its speed, reliability, and price continue to evolve to the benefit of portable recorders. The 722 can write to and read from CF as either its sole recording medium or simultaneously with the internal hard drive.

When to Use CF

The key benefits of CF include:

- wider temperature range capability than hard drives
- increased shock immunity versus hard drives
- convenient media insertion and removal
- established workflow and ubiquitous card readers and transfer tools

Formatting

Upon insertion of an unformatted (or non-FAT32 formatted) CF medium, the 722 will prompt the user to format the card. If the card is formatted as a FAT32 volume the card will be ready for selection as a recording volume. To reformat the CF medium, follow the same procedure as formatting the hard drive, substituting the CF menu selection for the hard drive.

Formatting the CF rebuilds the FAT (file allocation table) and erases any audio or other data files present on the medium. While some PC utilities can recover files immediately after formatting the drive, consider that the files have been permanently erased. FAT32 volumes generated by the 722 may not be compatible with numerous consumer electronic devices, including entry-level digital cameras.

After recording has stopped, it may take several seconds for the 722 to finish “housekeeping” on CF. When preparing to remove the CF, always observe the amber activity LED for the CF medium. If it is lit, wait until it goes out before removing the CF. If the CF is removed while the LED is lit, at the very least the file will be corrupted and there is a possibility of FAT corruption as well.

Testing



CF cards varied widely in their write/read throughput. Later generation "24x" and greater CF cards can reliably read and write multi-track, high sample rate audio. The 722 includes a drive speed test to measure the throughput speed of CF medium. Measured numbers greater than 3000 KB/s can reliably write 24/192 audio.

Not all CF medium can sustain write speeds for reliable 192 kHz recording. Use the speed test utility to make certain that installed medium can support the selected number of tracks at 192 kHz.

Drive Repair

The same drive repair utilities are available for the CF as the internal hard drive.

Qualified CF Cards

Several CF mediums have been tested and "approved" for use in the 7-Series, including Lexar Media, SanDisk, and Kingston Technology cards in capacities from 128 MB and above will successfully operate in the 722. The unit will support up to 2 TB of data. It is not feasible for Sound Devices to test all available CF cards for compatibility or maximum throughput with the 722. Use the CF transfer speed test to verify that an installed card can support the needed read/write speed.

Storage Medium – External FireWire Drives

The FireWire port on the 722 can function in either "host" mode or "drive" mode (see [File Transfer Using FireWire](#) for additional information on drive mode). In host mode an attached FireWire storage volume such as a hard drive or DVD-RAM can be used to record and play back audio files. Because the 7-Series can write to all available mediums simultaneously the ability to write to an external drive reduces the need for post-record copying of sound files.

External hard drive is attached and is selected as the recording destination



External FireWire drives require 2.0-ready 722 hardware. Only recorders specifically labeled 2.0 ready are able to connect to external FireWire drives as an available storage medium.

When to Use External FireWire Drives

The key benefits of recording to external drives include:

- the choice of drive types include DVD-RAM optical drive or hard drive
- near limitless recording capacity when a large volume external hard drive is attached (up to 2 TB)

- fast, no-waiting simultaneous record option
- post-record copying to quickly back up internal hard drive or CF medium

Formatting

Identical to both the internal hard drive and Compact Flash, attached FireWire drives are formatted as FAT32 volumes. Upon connection to an unformatted (or non-FAT32 formatted) external drive, the 722 will prompt the user to format the drive. If the drive is already formatted as a FAT32 volume the drive will be ready to be selected as a storage medium. The front panel drive LED will illuminate to show which drives are available for recording. To reformat an attached drive, follow the same procedure as formatting the internal hard drive, substituting the external drive menu selection for the internal hard drive.

After recording to an external drive has stopped, it may take several seconds for the 722 to finish “house-keeping” on drive. This is especially true when recording to DVD-RAM disks, which generally have slower throughput than hard drives. When preparing to disconnect a FireWire drive, always observe the amber activity LED labeled EXT. If it is lit, wait until it is off before disconnecting the drive. If the drive is disconnected while the LED is on, there is a high likelihood that the file being written will be unusable and there is a possibility of FAT corruption on the drive.

FireWire Bus Powering

The six-pin FireWire port on the 722 provides power for bus-powered FireWire drives. The following conditions should be observed when connecting to bus-powered drives.

- Bus powering a drive requires external DC powering of the 722. The 722 cannot operate bus-powered drives from an attached Li-ion battery.
- When recording in realtime to bus-powered FireWire drives the XL-1394 FireWire Power Filter is recommended. This filter network isolates the electrical noise in bus-powered drives from the 722.
- While hot-swapping FireWire cables is possible it is recommended to attach bus-powered drives with the recorder turned off.

Qualified Drives

External FireWire storage volumes that can be formatted and addressed as FAT32 can be used with the 722. These include:

- external hard drives, bus-powered or mains powered. Drives as large as 2 TB can be addressed,
- FireWire Compact Flash card readers,
- DVD-RAM drives.

FireWire drives use a variety of chipsets to perform conversion from the drive’s native format (i.e. IDE) to FireWire. Sound Devices has tested and qualified enclosures and card readers which use the Oxford 911, Oxford 922, PL3507, GL711, and FW912 chipsets. Other chipsets may operate, but Sound Devices does not officially support them. To check for compatibility with the 722 attach a FireWire drive and run the media speed test selected from the User Menu. This will write, then read a file to the drive. If the drive can perform this test then it can be used to record audio.

DVD-RAM Drives

DVD-RAM drives are essentially optical hard drives. Revision 2.00 firmware supports recording to and playing back from DVD-RAM drives when formatted as FAT32 volumes.

When recording to DVD-RAM drives in realtime it is important to note the following:

1. Keep sampling rates below 48048.

2. Record to polyphonic file formats.
3. Use DVD-RAM drive mechanisms and media that support 3X recording speeds.

Post-record copying from internal hard drive (or CF) to external drives is recommended with material recorded at high sampling rates.

File Transfer – FireWire

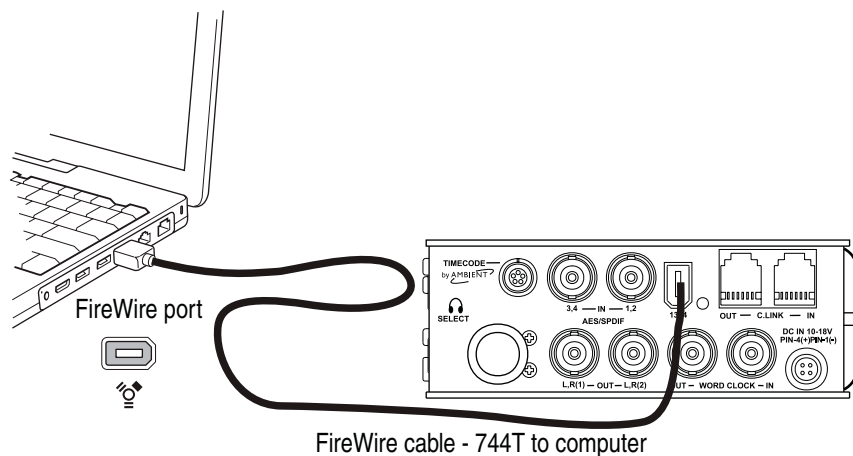

The 722's FireWire (IEEE-1394) port makes transferring of recorded files to a computer quick and easy. When connected to a computer, the internal hard drive and Compact Flash card of the 722 will mount to a Mac OS X or Windows computer as a local, removable mass storage volume. Using Mac Finder, Windows Explorer, or any other file utility, files can be copied, read, and deleted directly to and from the 722 hard drive.

It is best practice to copy original audio files from the original recorded medium to another volume before editing.

To mount the 722 to a computer via FireWire:

1. Stop all playback and recording activity.
2. Interconnect the 722 to a FireWire-enabled computer using an appropriate FireWire cable. No drivers are required if the computer meets the requirements listed in Specifications.
3. The 722 will now show COMPUTERCONNECTION on the LCD. When connected, all audio functionality of the 722 is defeated.
4. Navigate the drives on the computer and copy all needed audio to local storage.

To avoid possible corruption on the 722 hard drive, always properly dismount the unit from the operating system. On Mac platforms, drag the drive icons to the trash. On Windows platforms, use the "Disconnect External Media" icon in the system tray.

To disconnect the 722 from FireWire:

1. Make certain that any software applications that reference the 722 drive are closed and that all file copy functions to and from the 722 have completed.

2. In Mac OS X highlight the drive icon on the desktop and select ⌘-e to eject the volume. Alternatively, drag the drive icon to the trash in the dock.
2. In Windows, right-click the drive icon and select “eject.”
3. The cable between the computer and 722 can now be disconnected. If a future connection is going to be made the cable can be left connected.

If the 722 is disconnected from the computer via an eject command and the FireWire cable is still physically connected between the computer and recorder, the data connection can be made by entering the setup menu select **Firewire: Connection**. Alternatively, press the STOP key and HDD key together to begin a FireWire connection.



Different than when dismantling the 722 in Windows, with Mac OS, if a 722 is disconnected from FireWire by pulling the FireWire cable without first dismantling the drive the following error will appear.



While it is typically safe to disregard this message and hit the soft key X, it is best practice to properly remove the 722 from a Macintosh by dragging the volume to the trash or by using the keyboard shortcut ⌘-e .

Powering

The 722 is powered from either removable, Li-ion rechargeable batteries or external DC power. The included, removable 7.2 V Li-ion cell can be used as a primary or backup power source. The 722 automatically chooses the power source based on the voltage level of the external power supply. If it falls below a factory-set threshold, the unit will transition to Li-ion power. The transition between external and removable battery powering is seamless and has no affect on recording or playback operation.

During typical operation the 722 will run for approximately four hours from the included 4800 mAh Li-ion battery.

Lithium Ion Rechargeable Battery

The 722 is compatible with Sony-mount L- or M-type Li-ion rechargeable batteries. Numerous power capacities are available in these battery types, ranging from 1000 mAh to 7000 mAh. The 722's mount accommodates unlimited battery depth. Larger amp-hour cells provide more run time.

When powered by the removable Li-ion battery the LCD displays the battery voltage. The nominal operating voltage for Li-ion batteries is 7.2 V, with operating voltages ranging between 6.5–8.5 V. When the battery drops to 6.5 V, the LCD voltage display and the power LED begin flashing to warn that the battery is nearly depleted. When the voltage reaches 6.3 volts the 722 will power down—any recordings in-process will automatically be closed (stopped).

External Powering and Battery Charging

The 722 can be powered externally from 10–18 VDC (2 amp minimum). External DC fully powers the unit and charges an attached Li-ion battery simultaneously using the 722's onboard Li-ion charger. The charger circuit operates whenever the unit is powered on and optionally when the unit is off, depending on the external power wiring (*see below*).

DC input uses a 4-pin Hirose connector (Part # HR10-7P4P). There are two connection options available:

External DC Input Wiring	Operation
pin-2 to negative (-) pin-3 to positive (+)	operates the on-board Li-ion charger when the unit is both turned on and off. Use when plugged into AC power
pin-1 to negative (-) pin-4 to positive (+)	operates the on-board Li-ion charger only when the unit is turned on—there is no external current draw when powered off. Use when connecting to an external battery pack
Regardless of whether pins-1 and -4 or pins-2 and -3 are used, the unit will always charge the Li-ion battery when the unit is powered on.	

Pin-1 and pin-2 of the external DC input are at the same ground potential as chassis and signal ground.

The voltage level of the source powering the unit is shown on the LCD (**EXT 12.00**). When the 722 senses a low voltage condition from an external DC source the power LED and battery voltage display flashes, to alert the user. When the external DC reaches 9 volts, the 722 will automatically switch over to the removable battery. If no battery is installed the unit will shut down.

The included AC-to-DC “wall-wart” power supply operates the unit and charges the removable batteries simultaneously. Pins-3 and -4 are wired to (+) and pins-1 and -2 are wired to (-).

When power is applied, the charging circuit evaluates the battery condition and supplies charging current, if necessary. When charging, the amber charge LED will flash. Once the battery is fully charged, the charger will turn off and the amber charge LED will light solid, indicating a full charge. Large capacity cells increase the charge time.

Charge LED Activity	Description of Activity
Off	Charger disabled
On	Completed charge / battery fully charged
1 blink	Charger enabled / battery is charging
2 blinks	No Li-ion battery attached
3 blinks	High/low internal temperature state
4 blinks	Battery level error code (>15 min. in slow mode)
5 blinks	Error - recharging has been operating for over 8 hours without full charge

If the charge LED shows anything but a successful charge, the Li-ion battery may require replacement.

Time of Day Battery

The 722 has an internal NiMH LR6 (AA) battery to power to the time-of-day clock and date. This battery is charged simultaneously with the Li-ion battery. The AA battery holds the time of day and date for approximately 60 days.

Auto Functions with External Powering

The 722 can perform several functions when DC power is applied to and removed from the recorder. Options available include:

- **Power on unit** – unit will turn on and be ready for operation.
- **Power on and begin recording** – unit will power on and begin recording with the settings used when previously powered down.
- **Power on, power off unit** – external DC functions as the on/off switch.
- **Power on and begin recording, power off** – unit will power and begin recording, then turn off when power is removed.

These functions are useful when the unit is part of a production kit powered by a single power source. A single power switch can be used to power on the whole kit.

In addition to the internal record timer, the auto functions (power on/begin record/power off) can be used for more extensive unattended recording control. Using an outboard timer attached to a DC supply the 722 can be placed and activated to record events including EFX or nature, and for surveillance applications.

Firmware Upgrades

The 722 uses upgradable EEPROM (electrically erasable programmable read-only memory) to hold the unit's operating system software, or firmware. Firmware is the source code which controls all aspects of the device, including: signal routing, signal processing, menu options, LED's, controls, and data ports.

Version Information

During manufacturing the unit's hardware revision number and serial number are burned into a protected area of the EEPROM. This information is not modifiable. These numbers are viewed in the **Info:Version** selection of the setup menu. **Info:Version** also shows the firmware version of the recorder.

The 722 firmware version and unit serial numbers are written to the data chunk of every WAV audio file generated by the 722.



Upgrade Process

From time to time Sound Devices may issue revisions (new versions) of firmware for the 722. Firmware is user-upgradeable. To upgrade firmware follow the steps below.

1. Download the firmware file from the Sound Devices web site.
2. Transfer the firmware file (it will be named **version _ number.prg**) to the 722 internal hard drive via FireWire or onto a CF card. If there are multiple firmware files on the media, the 722 will select the first firmware file available. There is no provision to skip to the next file. To prevent confusion, ensure that there is only one firmware file available on any 722 media.

3. Enter the firmware upgrade menu. You will be prompted to search for the firmware file. If a valid firmware file is present on either the internal hard drive or CF the recorder will prompt if the path is the proper file to use. Press the Rotary Switch or the tone key to say yes. The 722 will begin firmware upgrade and validation. Progress is indicated with a bar graph.

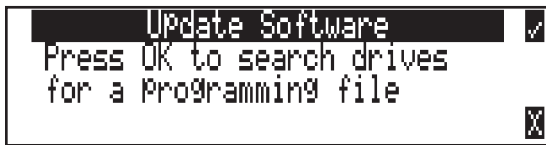

4. When the upgrade and verify process is complete, power cycle the 722. On power-up the LCD will turn solid black and the green LED next to the FireWire port will blink 20 times. When the update sequence is complete, the 722 will reboot once again.
5. Verify the firmware version using the **Info: Software** menu.
6. Reset the time-of-day clock to the present time and date.

Firmware upgrades are designed to preserve all user menu settings. As a precaution, we recommend saving the present state as a setup file on the hard drive or CF. Once a firmware upgrade is complete, restore settings from this file, if necessary.

Setup Menu Presets

Presets are useful shortcuts to speed setting the numerous parameters available in the setup menu. The 722 has four built-in presets and unlimited user presets.

Built-In Presets

The 722 is shipped from the factory with the factory preset applied. Its settings are listed below. Three additional presets, film, reporter, and music presets allow for quick setup of typical parameters for the defined application. Presets are applied by entering the setup menu and selecting the preset. All previous settings are lost when a preset is applied.

722 Presets	Factory Preset	Film Preset	Reporter Preset	Music Preset
Rec: FireWire Connection	Computer Connect	Computer Connect	Computer Connect	Computer Connect
Rec: Sampling rate	48 kHz	48 kHz	44.1 kHz	44.1 kHz
Rec: Bit Depth	24 bits	24 bits	16 bits	16 bits
Rec: File Type	.wav poly	.wav mono	.wav mono	.wav poly
Rec: Media Select	EXHDD and INHDD and CF	EXHDD only	INHDD only	EXHDD only
Rec: Scene Name/Number	None	None	None	None
Rec: Track Names	Track A: Track A Track B: Track B	Track A: Track A Track B: Track B	Track A: Track A Track B: Track B	Track A: Track A Track B: Track B
Rec: Take Name/Number	T 01	T 01	T 01	T 01
Rec: Take Reset Mode	When Scene is changed	When Scene is changed	When Scene is changed	When Scene is changed
Rec: Pre-Roll Time	2 Sec	2 Sec	2 Sec	2 Sec
Rec: Dither	Off	Off	On	On
Rec: Timer Start	Disabled	Disabled	Disabled	Disabled
Rec: Timer Stop	Disabled	Disabled	Disabled	Disabled

722 Presets	Factory Preset	Film Preset	Reporter Preset	Music Preset
Rec: Error Handler	Keep Recording, to a new file	Keep Recording, to a new file	Keep Recording, to a new file	Keep Recording, to a new file
Rec: Record Indicator	Normal Numbers	Normal Numbers	Normal Numbers	Normal Numbers
Input: Routing	1->A / 2->B	1->A / 2->B	1->A,B / 2->A,B	1->A / 2->B
Input 1: 48V Phantom	Off	On - Mic	On - Mic	On - Mic
Input 2: 48V Phantom	Off	On - Mic	On - Mic	On - Mic
Mic Inputs: Limiter	Enabled	Enabled	Enabled	Enabled
Mic Input 1: Low Cut	Disabled	Disabled	Enabled	Disabled
Mic Input 2: Low Cut	Disabled	Disabled	Enabled	Disabled
Mic Input 1: Low Cut Frequency	40 Hz, 12 dB/oct	40 Hz, 12 dB/oct	40 Hz, 24 dB/oct	40 Hz, 12 dB/oct
Mic Input 2: Low Cut Frequency	40 Hz, 12 dB/oct	40 Hz, 12 dB/oct	40 Hz, 24 dB/oct	40 Hz, 12 dB/oct
Mic Input 1: Gain Range	Normal	Normal	Normal	Normal
Mic Input 2: Gain Range	Normal	Normal	Normal	Normal
Input 1,2: Source	Auto Select	Auto Select	Auto Select	Auto Select
Input 1,2: Linking, MS	Unlinked	Unlinked	Unlinked	Linked 1,2
Line Input 1,2: Gain Ctrl	Use Front Panel Knobs	Use Front Panel Knobs	Use Front Panel Knobs	Use Front Panel Knobs
Input 1: Delay	0 usec	0 usec	0 usec	0 usec
Input 2: Delay	0 usec	0 usec	0 usec	0 usec
File: Marker Mode	New File	New File	New File	New File
File: Max Size	2G CF (1.8 GB)	2G CF (1.8 GB)	2G CF (1.8 GB)	2G CF (1.8 GB)
File: Folder Options	None	None	None	None
File: Copy Files	Copy all INHDD > CF	Copy all INHDD > CF	Copy all INHDD > CF	Copy all INHDD > CF
File: Copy Flag Reset	Enabled	Enabled	Enabled	Enabled
Output1 Left: Source	Track A	Track A	Track A	Track A
Output1 Right: Source	Track B	Track B	Track B	Track B
Output1 L,R: Attenuation	0 dB	0 dB	0 dB	0 dB
Output2 Left: Source	Track A	Track A	Track A	Track A
Output2 Right: Source	Track B	Track B	Track B	Track B
Output2 L,R: Attenuation	0 dB	0 dB	0 dB	0 dB
Digital Output: Mode	Consumer	Consumer	Consumer	Consumer
Play: AutoPlay Mode	Play All	Play All	Play All	Play All
Time/Date: 12/24 Hr	12 Hr	12 Hr	12 Hr	12 Hr
Time/Date: Date Format	MM/DD/YY	MM/DD/YY	MM/DD/YY	MM/DD/YY
LCD Contrast	50%	50%	50%	50%
Meter: Ballistics	Peak Hold + VU	Peak Hold + VU	Peak Hold + VU	Peak Hold + VU
Meter: Peak Threshold	0 dBFS	0 dBFS	0 dBFS	0 dBFS
Meter: Stealth Mode	Off	Off	Off	Off
HP: Rotary Sw Function	Selects Favorite Mode	Selects Favorite Mode	Selects Favorite Mode	Selects Favorite Mode

722 Presets	Factory Preset	Film Preset	Reporter Preset	Music Preset
HP: Monitor Modes	01> Inputs 1,2 02> Tracks A,B 03> Input 1,1 04> Input 2,2 05> Monitor A,B	01> Inputs 1,2 02> Tracks A,B 03> Input 1,1 04> Input 2,2 05> Monitor A,B	01> Tracks A,B	01> Inputs 1,2 02> Tracks A,B 03> Input 1,1 04> Input 2,2 05> Monitor A,B
HP: Favorite Mode	Tracks A,B	Tracks A,B	Tracks A,B	Tracks A,B
HP: Playback Mode	Tracks A,B	Tracks A,B	Tracks A,B	Tracks A,B
HP: Warning Bell	-30 dBFS	-30 dBFS	-30 dBFS	-30 dBFS
HP: Record/Stop Bell	Disabled	Disabled	Disabled	Disabled
Tone: Level	-20 dBFS	-20 dBFS	-12 dBFS	-12 dBFS
Tone: Frequency	1000 Hz	1000 Hz	1000 Hz	1000 Hz
Tone: Mode	To Rec Tracks and Outputs	To Rec Tracks and Outputs	To Rec Tracks and Outputs	To Rec Tracks and Outputs
INHDD: Empty Trash	Empty Trash	Empty Trash	Empty Trash	Empty Trash
CF: Empty Trash	Empty Trash	Empty Trash	Empty Trash	Empty Trash
EXHDD: Empty Trash	Empty Trash	Empty Trash	Empty Trash	Empty Trash
Power: Ext Low Batt Volt	11.0 volts	11.0 volts	11.0 volts	11.0 volts
Power: Ext Power Function	Do Nothing	Do Nothing	Do Nothing	Do Nothing
Ext Keyboard: Assign	F1 > Record F2 > Stop Button F3 > Rewind Button F4 > Play Button F5 > Fast Forward Button CTRL + C > File: Copy Files Last 24Hr CF > EXHDD CTRL + H > File: Copy Files Last 24Hr INHDD > EXHDD	F1 > Record F2 > Stop Button F3 > Rewind Button F4 > Play Button F5 > Fast Forward Button CTRL + C > File: Copy Files Last 24Hr CF > EXHDD CTRL + H > File: Copy Files Last 24Hr INHDD > EXHDD	F1 > Record F2 > Stop Button F3 > Rewind Button F4 > Play Button F5 > Fast Forward Button CTRL + C > File: Copy Files Last 24Hr CF > EXHDD CTRL + H > File: Copy Files Last 24Hr INHDD > EXHDD	F1 > Record F2 > Stop Button F3 > Rewind Button F4 > Play Button F5 > Fast Forward Button CTRL + C > File: Copy Files Last 24Hr CF > EXHDD CTRL + H > File: Copy Files Last 24Hr INHDD > EXHDD
Ext Keyboard: Language	English	English	English	English
CL-1: Re-Program	CL-1 Module	CL-1 Module	CL-1 Module	CL-1 Module
CL-1: Logic Out Assign	(Undefined)	(Undefined)	(Undefined)	(Undefined)

User Setups

All of the set parameters in the table above can be saved in a file to internal hard drive or to CF card. By entering the Get/Save Setup Menu, the user can save or retrieve parameters to a data file. This binary file is named **722.SUP** and is saved in the **SOUNDDEV** folder on the selected medium.

Setup Menu

The setup menu controls a wide range of parameters for the 722, including all audio routing and recording settings. The setup menu is a single, flat architecture with no sub-menus, easing navigation. Each setup controls a specific parameter with several selections. The chart below shows the setup number, a description of the control, and the menu options available.

#	Setup Name	Setup Description	Setup Options
1	Quick Setup	Allows the user to quickly apply default menu setups and save/retrieve user setups to disk or CF.	<ul style="list-style-type: none"> • Load Factory Settings - restores the factory default settings • Load Film Settings - applies typical setups for film production • Load Reporter Settings - applies typical setups for voice recording • Load Music Settings - applies typical setups for music recording • Load User from INHDD - applies settings saved by user to hard disk • Load User from CF - applies settings saved by user to CF • Save User to INHDD - saves present state to file on hard drive • Save User to CF - saves present state to file on CF
2	FireWire: Connection	Activates FireWire drive mode.	<ul style="list-style-type: none"> • Computer/Connect (STOP+HDD buttons) • External Drive
3	Rec: Sample Rate	Sets the audio sampling frequency of the 722	<ul style="list-style-type: none"> • 32 kHz • 44.1 kHz • 48 kHz • 48.048 kHz • 48.048k F • 88.2 kHz • 96 kHz • 96.096 kHz • 96.096 k F • 176.4 kHz • 192 kHz
4	Rec: Bit Depth	Sets the bit depth of the 722 recordings.	<ul style="list-style-type: none"> • 16 bit, • 24 bit
5	Rec: File Type	Selects the file format (type) recorded to the selected medium.	<ul style="list-style-type: none"> • .WAV poly • .WAV mono
6	Rec: Media Select	Selects the storage media used for recording. Media is selectable even if it is not present.	<ul style="list-style-type: none"> • INHDD Only • CF Only • EXHDD Only • INHDD and CF • EXHDD and INHDD • EXHDD and CF • EXHDD and INHDD and CF
7	Rec: Scene Name/Number	User-defined, alpha-numeric file scene names can be pre-set and selected from a list. Scene name lists can be saved to hard drive.	<p><up to 9 alpha-numeric characters can be entered for the scene name></p> <p>Scene name can also be left blank</p>
8	Rec: Track Names	used to identify a track name which shows up in iXML and BWF metadata	<ul style="list-style-type: none"> • Track A • Track B • Track C • Track D • Mix • Boom • <Add New Entry> • <Load List From INHDD> • <Save List From INHDD>
9	Rec: Take Name/Number	Numeric, auto-incrementing number used for take identification.	<selectable alpha character + integers up to 32000, with or without preceding 0's>

#	Setup Name	Setup Description	Setup Options
10	Rec: Take Reset Mode	Defines when take numbers are reset. Reset brings take number to <1>.	<ul style="list-style-type: none"> • Never <ul style="list-style-type: none"> - take numbers do not reset • When scene is changed <ul style="list-style-type: none"> - take resets when scene name is changed • When daily folder changes <ul style="list-style-type: none"> - takes reset on new day • Either scene or daily <ul style="list-style-type: none"> - takes reset on either change
11	Rec: Pre-Roll Time	Selects the amount of pre-roll time the 722 will add to the beginning of each file.	<ul style="list-style-type: none"> 0–10 sec. @ 48 kHz 0–5 sec. @ 88.2–96.096 kHz 0–2 sec. @ >96.096–192 kHz
12	Rec: Dither	Selects whether to dither is added to 24 bit digital signals while recording 16 bit files.	<ul style="list-style-type: none"> • Off • On (16 bit only)
13	Rec: Timer Start	Sets a specific start time/date for unattended recording. Unit must be powered.	<enter time, date>
14	Rec: Timer Stop	Set a specific time/date to stop recording. May be used with or without the Rec: Timer Start. May be set before the Timer Start time to temporarily stop recording and then resume recording with Timer Start.	<enter time, date>
15	Rec: Error Handler	Sets the behavior when a hard drive write error occurs.	<ul style="list-style-type: none"> • Stop recording • Keep Recording to New File
16	Rec: Record Indicator	Sets how the large display looks when the unit enters record.	<ul style="list-style-type: none"> • Normal Numbers • Reverse Numbers • Flash Numbers
17	Input: Routing	Allows the user to setup their routing matrix among all available inputs and tracks. There are preset routings and three custom routings available. Pressing the input select key repeatedly will cycle through all preset routings. Primarily accessible from the Input Select Key.	<ul style="list-style-type: none"> • 1 → A • 1 → A / 2 → B • 1 → A / 1 → B • 1 → A,B / 2 → A,B • Custom Route 1 • Custom Route 2 • Custom Route 3
18	Input 1: 48V Phantom	Enables or disables 48 V phantom power on inputs 1 and 2.	<ul style="list-style-type: none"> • Off • On - Mic • On - Mic and Line
19	Input 2: 48V Phantom		
20	Mic Inputs: Limiter	Enables or disables the analog input limiter on input 1 and 2 mic preamps.	<ul style="list-style-type: none"> • Disabled • Enabled
21	Mic Input 1: Low Cut	Enables the high-pass (low cut) filter to reduce sensitivity to low frequencies.	<ul style="list-style-type: none"> • Disabled • Enabled
22	Mic Input 2: Low Cut		
23	Mic Input 1: Low Cut Freq	Selection of twelve high-pass filter frequency and slope combinations for microphone inputs.	<ul style="list-style-type: none"> • 40, • 80, • 160, • 240 Hz @ 12 dB/oct • 40, • 80, • 160, • 240 Hz @ 18 dB/oct • 40, • 80, • 160, • 240 Hz @ 24 dB/oct
24	Mic Input 2: Low Cut Freq		
25	Mic Input 1: Gain Range	Selects the sensitivity of the microphone input. Low sensitivity is used for very loud and/or very hot microphones.	<ul style="list-style-type: none"> • Normal • Low
26	Mic Input 2: Gain Range		
27	Input 1, 2: Source	Forces the inputs to analog or digital mode.	<ul style="list-style-type: none"> • Auto-select • Analog • Digital (S/PDIF/AES) • Disabled (Power Save)

#	Setup Name	Setup Description	Setup Options
28	Input 1,2: Linking, MS	Selects whether the input 1 & 2 levels are controlled independently or grouped as a pair with or without mid-side decoding.	<ul style="list-style-type: none"> • Unlinked Inputs 1 and 2 operate independently • Linked 1/2 Inputs are linked, channel 1 pot controls level, channel 2 pot controls pan • Linked 1/2 and MS Inputs are linked, channel. 1 pot controls level, channel. 2 pot controls pan and are decoded for MS stereo.
29	Line Input 1,2: Gain Control	When inputs 1 and 2 are in LINE input mode, selects whether the gain setting is controlled by the front panel knobs or by the menu sensitivity settings below.	<ul style="list-style-type: none"> • Use front panel knobs • Use sensitivity settings
30 31	Line Input 1: Gain Line Input 2: Gain	Adjusts the input sensitivity in 0.1 dB steps -6 dB and +18 dB.	Meters show a pre-fader level of the input signal of both inputs on their respective meters to aid in the adjustment.
32 33	Input 1: Delay Input 2: Delay	Sets a digital delay for each input. Can be used to compensate for delay in various digital wireless microphone units or digital processors.	0 μsec to 30,000 μsec up to 48.048 kHz Fs 0 μsec to 15,000 μsec up to 96.096 kHz Fs 0 μsec to 7,500 μsec up to 192 kHz Fs
34	File: Marker Mode	Enables the user to set cue points on the fly while recording by pressing the record key.	<ul style="list-style-type: none"> • Markers disabled No cue marks are set. • New Cue Cue markers will be set within one contiguous file. • New File A new file is started with each press of the record key, the take counter is increased by one.
35	File: Max Size	Selects the file size where the 722 will close, then start a new file. The 722 will not record a file larger than the selected size. The largest file permissible with the 722's FAT32 file system is 4 GiB	<ul style="list-style-type: none"> • 4 GB 3.6 GB • 2 GB 1.8 GB • 1 GB 950 MB • 640 MB 450 MB
36	File: Folder Options	Allows user to organize files in root and sub-folders. To not use any folders select <None> on every level.	<ul style="list-style-type: none"> • TOP-LEVEL <None>, <Add new entry> • MID-LEVEL <None>, <Add new entry>, <Daily> • BOTTOM-LEVEL <None>, <Add new entry>, <Scene>
37	File: View Files	Enters the file directory tree for the selected drive.	Highlight media descriptor to navigate the menu
38	File: View Take List	Allows user to view the last 200 takes. Takes can be selected and converted to circle takes.	• Circle
39	File: Copy Files	Allows the user to select a file or a range of files to be copied from one storage media to another. Files will only be copied from their current directory to a directory of the same name on the other media. If a file will not fit on the destination media, user is given the option to skip that file and continue with the copy or abort the copy all together. User is advised at the end of the copy process how many files were copied successfully.	<ul style="list-style-type: none"> • Copy all {drive} → {drive} • Last 24 hr {drive} → {drive} • Last 48 hr {drive} → {drive} • Flagged {drive} → {drive} <hr/> <i>All files, when recorded, automatically have their flag bit set to "on"</i>
40	File: Copy Flag Reset	Selects whether the flag bit is cleared or not on files copied from one media to another.	<ul style="list-style-type: none"> • Disabled • Enabled

#	Setup Name	Setup Description	Setup Options
41 42	Output 1 Left: Source Output 1 Right: Source	Selects the signal source for the Master Output Bus (TA3 outputs, tape outputs, and digital 1 outputs).	<ul style="list-style-type: none"> • Input 1 • Input 2 • Track A • Track B • Input 1+2 • Track A+B
43	Output 1 L,R: Attenuation	Selects the attenuation level of signal sent to the Master Output Bus.	selectable from 0 to -40 dBFS
44 45	Output 2 Left: Source Output 2 Right: Source	Selects the signal source for output bus 2 sent to digital output bus 2.	<ul style="list-style-type: none"> • Input 1 • Input 2 • Track A • Track B • Input 1+2 • Track A+B
46	Output 2 L,R: Attenuation	Selects the attenuation level of the signal output to bus 2.	selectable from 0 to -40 dBFS
47	Digital Output: Mode	Selects whether or not the consumer SPDIF bit is applied or not in the AES3id output.	<ul style="list-style-type: none"> • Consumer • Professional
48	Play: AutoPlay Mode	Allows user to play file(s) consecutively from selected directory, one time through or continuously. Great for playing an MP3 collection during down time!	<ul style="list-style-type: none"> • Disabled • Play all • Repeat one • Repeat all
49	Time/Date: 12/24 Hr	Selects between 12 hour and 24 hour time.	<ul style="list-style-type: none"> • 12 hr • 24 hr
50	Time/Date: Date Format	Selects the date syntax of the recorder.	<ul style="list-style-type: none"> • mm/dd/yy • dd/mm/yy
51	Time/Date: Set	Sets the internal date and time of the 722. Resetting the time re-jams the internal time code generator to the set time. Setting the internal clock during a production day will require time code devices to be re-jammed.	<p><time, date></p> <p>Clock is not set until <done> is selected</p>
52	LCD: Contrast	Adjusts the contrast level of the LCD display.	0-100%
53	Meter: Ballistics	Selects among five different meter ballistics settings	<ul style="list-style-type: none"> • VU only • Peak only • Peak-hold only • Peak+VU • Peak-hold + VU
54	Meter: Peak Threshold	User-set level in dBFS where track peak LED's illuminate. 0 LED doubles as track peak indicator.	0 to -20 dBFS (1 dB increments)
55	Meter: Stealth Mode	Enables LEDs to toggle on and off with the LCD backlight key.	<ul style="list-style-type: none"> • Off • On
56	HP: Rotary Switch Function	Selects the functionality of the Rotary Switch's button when in record and playback.	<ul style="list-style-type: none"> • Disabled: push makes no change to the headphone matrix. • Selects Favorite Mode: in record and playback modes, push will change the headphone source immediately to the favorite selected in HP: Favorite Mode. • Playback/Monitor Drive Select: Selects the media source for file playback and record monitoring
57	HP: Monitor Modes	Select the sequence of the modes that appear in the Headphone Source Display on the LCD.	Up to 20 source selections can be entered in any order. See headphone monitor section in guide for adjustment and Favorite Mode below for list of headphone selections.

#	Setup Name	Setup Description	Setup Options
58	HP: Favorite Mode	Selects the audio source monitored when the Rotary Switch is pressed during recording or playback.	Inputs 1,2 Tracks A,B Monitor A,B Input 1,1 Input 2,2 Track A,A Track B,B Monitor A,A Monitor B,B Inputs 1,2 (MS) Tracks A,B (MS) Monitor A,B (MS) Inputs 1+2,1+2 Tracks A+B,A+B
59	HP: Playback Mode	Selects the audio source sent to headphones upon playback.	<ul style="list-style-type: none"> • No change • Same as options listed above
60	HP: Warning Bell Level	Set the output level of the multi-function warning bell.	off, -60 to -12 dBFS in 1 dB steps
61	HP: Rec/Stop Bell	Alerts the user with one beep at the start of recording and two beeps when the recording is stopped	<ul style="list-style-type: none"> • Disabled • Enabled
62	Tone: Level	Set the output level of the reference tone	-40 to 0 dBFS in 1 dB steps
63	Tone: Frequency	Allows the user to set the frequency of the reference tone oscillator	100-10,000 Hz in 100 Hz steps
64	Tone: Mode	Select the destination of the reference tone or to disables it completely	<ul style="list-style-type: none"> • disabled • to record tracks only • to outputs only • to record tracks and outputs
65	INHDD: Test	Performs a write/read speed test on the internal hard drive. Data transfer speed is measured in KB/s.	Caution: Drive test will disable processing and mute outputs for duration of test. Outputs will not return until test is exited.
66	INHDD: Space	Shows the drive file system, total size, and space remaining on the internal hard drive.	
67	INHDD: (Erase)	Formats the internal hard drive. Caution, while various PC utilities are able to recover files from a re-formatted drive, once formatted old audio data is not accessible by the 722.	<ul style="list-style-type: none"> • Empty Trash • Empty False Takes • Empty both
68	INHDD: Repair	Runs a utility to repair minor errors in the directory (FAT) of the drive.	
69	INHDD: Empty Trash	Allows user to delete files previously sent to the trash as well as false takes.	
70	CF: Test	Performs a speed test on the Compact Flash media installed. Data transfer speed is measured in KB/s.	Caution: Drive test will disable processing and mute outputs for duration of test. Outputs will not return until test is exited.
71	CF: Space	Shows the drive file system, total size, and space remaining on connected Compact Flash medium.	
72	CF: (Erase)	Formats installed Compact Flash medium Caution, while various PC utilities are able to recover files from re-formatted drives, once formatted, old audio data is not accessible by the 722.	
73	CF: Repair	Runs a utility that will repair minor errors in the directory structure of the Compact Flash.	

#	Setup Name	Setup Description	Setup Options
74	CF: Empty Trash	Allows user to delete files previously sent to the trash as well as false takes.	<ul style="list-style-type: none"> • Empty Trash • Empty False Takes • Empty both
75	EXHDD: Test	Performs a speed test on the external media attached. Data transfer speed is measured in KB/s.	Caution: Drive test will disable processing and mute outputs for duration of test. Outputs will not return until test is exited.
76	EXHDD: Space	Shows the drive file system, total size, and space remaining on connected Compact Flash medium.	
77	EXHDD: (Erase)	Formats attached FireWire storage volume Caution, while various PC utilities are able to recover files from re-formatted drives, once formatted, old audio data is not accessible by the 722.	
78	EXHDD: Repair	Runs a utility that will repair minor errors in the directory structure of the external FireWire storage volume.	
79	EXHDD: Empty Trash	Allows user to delete files previously sent to the trash as well as false takes.	<ul style="list-style-type: none"> • Empty Trash • Empty False Takes • Empty both
80	Balance Cal	Calibrates the center position of the input 2 pot when used as the balance control for MS recording.	Place balance control to center and press to select.
81	Power: Ext Low Batt Volt	Sets the warning voltage of the low battery alert with an external power source. Internal battery warning threshold is factory set.	10.0–18.0 VDC, 0.1 V steps
82	Power: Ext Power Function	Controls the behavior of the unit when power is applied to the external DC jack.	<ul style="list-style-type: none"> • Do Nothing • Power On Unit • Power On and Start Record • Power On/Off unit • Power On/Off unit and Record
83	Ext Keyboard: Assign	Enter to setup keyboard shortcuts when using the CL-1 keyboard interface	
84	Ext Keyboard: Language	Select the language of the keyboard attached to the CL-1.	<ul style="list-style-type: none"> • English • German • French
85	CL-1: Re-program	The CL-1 has its own firmware which is supplied from the 722. This utility updates the CL-1 firmware.	
86	CL-1: Logic Out Assign	Each logic output pin can be assigned to go high when the unit is in the selected mode. Logic input overrides logic output selection.	<ul style="list-style-type: none"> • Undefined • Stop • Play • Pause • Record
87	Info: Button Shortcuts	An informative menu showing the available keyboard shortcuts.	
88	Info: Version	Shows the hardware revision, serial number, and firmware version of the unit.	
89	Update Software	Upgrade tool used to apply new firmware. It will search all connected storage for the firmware file and prompt to update.	

Specifications

System

Sampling Frequency	internal: 32, 44.1, 48, 48.048, 88.2, 96, 96.096, 176.4, 192 kHz external: 32–192 kHz via word clock input
Internal Data Path and Processing	32 bit, 192 dB dynamic range
A/D, D/A Converters	24 bit, 192 kHz sample rate maximum. A/D converters on socketed, field-upgradeable daughter board
A/D Dynamic Range	114 dB, A-weighted bandwidth 110 dB, 20 Hz – 22 kHz bandwidth
D/A Dynamic Range	112 dB, A-weighted bandwidth 108 dB, 20 Hz–22 kHz bandwidth
Metering	38-segment (2 x 19), sunlight-viewable selectable peak, VU, or peak (with or without peak hold) with VU ballistics, variable brightness

Analog Input

(all measurements at Fs 96 kHz, 24 bit unless noted)

Frequency Response	Mic or Line: 10 Hz–40 kHz, +0.1, –0.5 dB (gain controls centered)
Equivalent Input Noise	Mic: –133 dBu max (–135 dBV), 50 ohm source, A-weighted filter Mic: –131 dBu max (–133 dBV), 50 ohm source, 20 Hz–20 kHz BW flat filter, gain fully up Mic: –130 dBu max (–132 dBV), 150 ohm source, A-weighted filter Mic: –128 dBu max (–130 dBV), 150 ohm source, 20 Hz–20 kHz BW flat filter, gain fully up
THD + Noise	Mic: 0.004% max (1 kHz, 22 Hz–22 kHz BW, gain control down, –15 dBu input) Line: 0.004% max (1 kHz, 22 Hz–22 kHz BW, gain control down, +16 dBu input)
Gain (input dBu to –20 dBFS)	Mic (normal gain mode): 25–70 dB Mic (low gain mode): 10–55 dB Line: –6–18 dB, 0.1 dB increments
Input Impedance	Mic: 7.5k ohm Line: 20k ohm
Input Clipping Level	Mic input: –5 dBu minimum (normal gain mode, gain control fully down) Mic input: +10 dBu minimum (low gain mode, gain control fully down) Line input: +26 dBu minimum (gain control fully down)
Input Topology	Mic and Line: fully electronically balanced, RF, ESD, short, and overload protected; pin-2 hot, pin-3 cold
Gain Matching	Line inputs: ±0.1 dB, channel-to-channel
Common Mode Rejection Ratio	Mic: 40 dB minimum at 80 Hz
High-Pass Filters	40, 80, 160, 240 Hz @ 12/18/24 dB/oct (all menu selectable)
Mic Powering (each XLR selectable)	48 V phantom through 6.8k resistors, 10 mA per mic available, menu-selected per channel in mic or line level positions
Mic Input Limiters	analog (pre-A/D converter), dual-stage optocoupler and FET, –4 dBFS threshold, 20:1 limiting ratio, 5 mS attack time, 200 mS release time

Output Analog

Line Output Clipping Level	+20 dBu minimum, 10k ohm load
Attenuation & Resolution	0–40 dB, 1 dB increments
Output Topology	Line: fully electronically-balanced, RF, ESD, short, and overload protected; pin-2 driven hot, pin-3 driven cold; let pin-3 float for unbalanced connections.

Inputs/Outputs – Digital

AES3-id 75 ohm, 0.5 V p-p, S/PDIF compatible with RCA adapter

Digital Storage

Internal hard drive ATA-5 interface 1.8-in or 2.5-in hard drive 4200–7200 RPM supported, FAT32 formatted, up to 2 TB addressable

Compact Flash CF type I, II, and + (microdrive) compatible, FAT32 formatted, up to 2 TB addressable

File Types WAV, mono or polyphonic, at supported Fs, 24-bit or 16-bit MP3 @ 64, 96, 128, 240, or 320 kb/s stereo

Utilities Format, speed test, and repair utility for internal HD and CF volumes

Data Transfer / Control

FireWire peripheral-mode, IEEE-1394a compliant, 6-pin FireWire, Windows 2000, XP, Mac OS X only

C. Link 6-wire modular input and output, RS-232 machine control, word clock, time code transfer (744T)

Powering

Internal Voltages ±16 VDC regulated audio rails
5 VDC data
3.3 VDC data
1.5 VDC DSP core
48 VDC phantom power

Power supply (batteries) operating cell, removable 7.2 V (nominal) Sony M- or L-type Li-ion, operational from 6–8 V

Power supply (external) 10–18 V, 1000 mA minimum, via locking 4-pin Hirose connector, use Hirose #HR10-7P-4P (DigiKey# HR100-ND) for locking mating DC connector; pin-1 (-), pin-2 (-), pin-3 (+), pin-4 (+). See [Powering](#) section for additional details

Environmental

Operation and Storage Ambient temperature 5–55° C,
Relative humidity (non-condensing) <80%

Other

LCD Display 202 x 32 pixels, extended temperature, backlit display

Tone Oscillator 100 Hz–10 kHz, variable output, assigned to tracks or outputs (menu-selectable)

Quick Setups Four factory presets, one user setup stored to CF or HD as data file







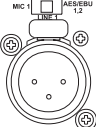
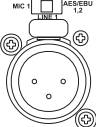
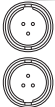

Dimensions and Weight

Size 45 mm x 209 mm x 125 mm (H x W x D)
1.8" x 8.2" x 4.9"

Mass unpackaged: 1.2 kg, (2.6 lbs) without battery

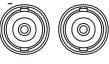
Connector Pin Assignments

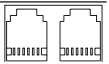
Each connector type, electrical characteristics, and pin assignment is shown below.

Connector		Pin Assignments	Notes
XLR (Analog Inputs)		1 – ground 2 – signal (+) 3 – signal (-)	7.5k ohm input impedance, mic level 20k ohm input impedance, line level active-balanced
XLR (AES Inputs)		1 – ground 2 – signal (+) 3 – signal (-)	transformer-balanced, for use 110 ohm twisted-pair cabling, AES3 specification
TA3M Master Output Bus		1 – ground 2 – signal (+) 3 – signal (-)	120 ohm output impedance, active balanced. For unbalanced connection, pin-1 ground, pin-2 hot, pin-3 not connected. Mates with Switchcraft TA3F-type connector.
3.5 mm Master Output Bus		tip – signal L ring – signal R sleeve – signal ground	Master Output Bus signal in an unbalanced, consumer-electronic level.
3.5 mm Headphone		tip – signal L ring – signal R sleeve – signal ground	mates with 3.5 mm TRS jack.
AES3id (S/PDIF) Input		center pin – signal sleeve – ground	BNC female, unbalanced, coaxial connection, 75 ohm connectors recommended
AES3id (S/PDIF) Output		center pin – signal sleeve – ground	BNC female, unbalanced, coaxial connection, 75 ohm connectors recommended
Word Clock Input and Output		center pin – signal sleeve – ground	BNC female, unbalanced, coaxial connection, 75 ohm connectors recommended
FireWire (-1394)		6-pin cabling	6-pin male FireWire cable, provides bus power at 12 volts when the unit is powered from external DC sources.
C. Link In / Out		1 – +3.3 V 2 – Tx (output) 3 – ground 4 – Rx (input) 5 – WC in 6 – TC in	Not a telephone jack!
Hirose 4-pin DC Input		1 – ground 2 – ground, same as pin-1 3 – DC (+) charge 4 – DC (+) operate	

Power Consumption Variables

The 722 draws power from either its on-board Li-ion battery or from external DC sources. Two factors need to be considered to calculate battery runtime—battery/power supply capacity and unit power consumption. The best determination of your run time is to experiment with a given recording setup.

The 722 power consumption varies over a range between 4 W to 20 W, depending on active functions. The following functions have the most significant affect on power consumption:

Inputs	Active analog inputs increase power consumption. If recording from digital sources, disable analog inputs, or inputs altogether to reduce power consumption. Analog inputs and the microphone preamps draw current whether they are idle or active. Active inputs draw 1.5 W compared to deactivated inputs.
Hard Drive Activity	When the unit is recording to or playing back from the internal hard drive, power consumption raises by approximately 2 W.
Microphone Powering	Phantom powered microphones draw power for operation. Up to 1 W can be drawn from the phantom supply.
Battery Chargers	Depending on the charge state of the on-board Li-ion and the internal AA time-of-day battery, the charging circuit can draw ~10 W from external DC.
Sampling Rate	The 722 draws more power at higher sampling rates. Each doubling of the sampling rate adds ~1 W of power consumption.

Recording Time Calculation

The calculation of available 722 recording time involves three factors:

- **track count** - how many concurrent audio tracks are selected for recording.
- **data rate** - calculated from the sample rate and bit depth for non-compressed audio and by bit rate for data compressed audio. Data rate determines how big the data “container” is for the audio signal (see the calculation below for determining PCM audio).
- **storage medium capacity** - typically expressed in GB

Uncompressed Recording Time in Track-Hours

	Data Rate (bit depth/sample rate), one track				
	16/44.1 (5.05 MB/min)	16/48 (5.49 MB/min)	24/48 (8.24 MB/min)	24/96 (16.5 MB/min)	24/192 (33.0 MB/min)
1	3.30	3.03	2.02	1.01	0.51
2	6.60	6.07	4.05	2.02	1.01
4	13.2	12.1	8.09	4.05	2.02
8	26.4	24.3	16.2	8.09	4.05
15	49.5	45.5	30.3	15.2	7.59
40	132	121	80.9	40.5	20.2
60	198	182	121	60.7	30.3
100	330	303	202	101	50.6

The chart above shows recording time available with the 722. Time is expressed in hours per track (track-hours) at the specified data rate supported by the 722. If recording two tracks, divide the track hours figure by two. Note that the 722 supports additional sample rate/bit depth combinations, however, only the most common are included below.

Record Time

The chart shows that when recording 24-bit/48 kHz audio to a 40 GB hard drive the maximum amount of recording time available roughly 80 track-hours. If recording a stereo two-track file, this yields 40 stereo hours of record time.

Note that most storage mediums now quote capacity in GB using SI units, where 1000 megabytes equals one gigabyte.

PCM Audio

Uncompressed digital audio is expressed numerically by two measurements, bit depth and sampling frequency, such as 16-bit/48 kHz. These two numbers are used to compute the data rate of uncompressed audio.

Audio Data Rate = Bit Depth x Sampling Frequency

In the example below the data rate of a single 16-bit/48 kHz audio stream is computed in megabytes per minute. Division by 1,048,576 converts from bits to megabits. Division by 8 converts from megabits to megabytes; multiply by 60 converts seconds to minutes.

$$((16 \times 48000) / 1,048,576) / 8 \times 60 = 5.49 \text{ MB/min}$$

MP3 Compressed Record Time in Hours

		MP3 Data Rate (bit depth/sample rate), stereo track						
		64 kb/s (0.47 MB/min)	96 kb/s (0.70 MB/min)	128 kb/s (0.94 MB/min)	160 kb/s (1.17 MB/min)	192 kb/s (1.40 MB/min)	256 kb/s (1.86 MB/min)	320 kb/s (2.34 MB/min)
Storage in GB (1000 MB = 1 GB)	1	35	23	17	14	11	8	7
	2	71	47	35	28	23	17	14
	4	142	94	71	56	47	35	28
	8	284	189	142	113	94	71	56
	15	533	355	266	213	177	133	106
	40	1422	948	711	568	474	355	284
	60	2133	1422	1066	853	711	533	426
	100	3555	2370	1777	1422	1185	888	711

The chart above shows recording time available with the 722 when recording to an MP3 file. Time is expressed in hours at the specified MP3 supported by the 722. Note that all recordings are two-channel recordings.

Compressed Audio

When digital audio is compressed using some form of lossy, perceptual process such as MPEG2-Layer3 (MP3 audio), Windows Media encoding (WMA), ATRAC encoding (used in MiniDisc), AAC (MPEG-4 audio), or others - it can have a significant reduction in its data rate. Compressed audio has enabled the practical distribution of audio over low speed data networks.

CL-1 Remote Control and Keyboard Interface

The CL-1 Remote Control and Keyboard Interface is an available hardware accessory to interface with PS/2 compliant computer keyboards and enable external devices to control the 722. When using the CL-1, front panel controls and menu selections on the 722 can be mapped to keyboard shortcuts, allowing for full keyboard control of the recorder. Additionally the CL-1 has contact closures for programming remote inputs or outputs. These are commonly used for machine control and “remote rolling” using a mixing console with transport controls.

Connecting the CL-1

1. Connect the included C. Link cable to the 722's C. Link Input connector.
2. Connect the opposite end of the C. Link cable to the CL-1's C. Link connector.
3. Connect a PS/2 keyboard to the PS/2 connector on the CL-1.
4. Connect switches between assigned pins 1-7 and pin-8 (ground) on the CL-1.

The C. Link port on the 722 provides power for CL-1 operation.

Keyboard Assignments

Standard keyboard shortcuts have been pre-assigned and are listed below.

Menu Keys

Shortcut Key	Function
Escape	Cancel – Exits without saving in all menus
Enter	Ok – Exits with saving in all menus (Check Mark or Edit)
Up Arrow	Mirrors the LCD Up Arrow in all menus
Down Arrow	Mirrors the LCD Down Arrow in all menus
Left Arrow	Mirrors the LCD RWD Arrow in all menus CustomRouteUI – Un-assign Route TimeMenu – Moves to previous field
Right Arrow	Mirrors the LCD FFWD Arrow in all menus CustomRouteUI – Assign Route. InRouteUI – Edit if on 'Custom Route' FileUI – Selects Options for Folders/Files when displayed ShortcutEditUI – Edit shortcut if on shortcut number Scene/TrackLists – Edits (Same as hitting Play button) TimeMenu – Moves to next field.
CTRL + Up Arrow	Setup UI Menu - Moves to the previous category
CTRL + Down Arrow	Setup UI Menu - Moves to the next category
Page Up	Setup UI Menu - Moves to the previous category or marker
Page Down	Setup UI Menu - Moves to the next category or marker Shortcut Edit UI Menu – Same as Enter
Home	Setup UI Menu - Moves to the top of the list. FileUI – Moves to the top of the list Shortcut Edit UI – Goes to first shortcut number or Hot Key StringUI – Goes to the beginning of the string
End	Setup UI Menu - Moves to the bottom of the list. Shortcut Edit UI – Goes to last shortcut number or Hot Key StringUI – Goes to the end of the string being edited
Delete	Scene/TrackLists – Deletes entry when permitted StringUI – Deletes character when permitted
Insert	Setup UI Menu - Toggles Markers StringUI – Inserts a space when permitted
“Hot Key”	Shortcut Edit UI Menu - Selects Hot Key In Set Key Mode Global - Executes Command if function is assigned to Hot Key
01 - 99 (number sequence)	Setup UI Menu – Jumps to menu list number. Shortcut UI Menu – Jumps to shortcut number.

String Edits & Take Name/Number (Renaming & Notes)

Hot Key	Function
ASCII Characters	Scene – Prints Character and moves to next character. Take – '0-9' – Prints Number, 'A-Z' – Prints Spacer
Backspace	Deletes previous character and moves one character to the left
Delete	Deletes currently selected character Take – Same as 'Reset' (Play Button)
Enter	Carriage Return if permitted, otherwise Ok – Exits with saving
CTRL + Enter	Ok – Exits with saving. (Only when Carriage Return is permitted.)
Insert	Inserts a space when permitted
Escape	Cancel – Exits without saving in both menus
Up Arrow	Increment Character in both menus
Down Arrow	Decrement Character in both menus
Left Arrow	Previous Character in both menus
Right Arrow	Next Character in both menus
Home	Goes to the beginning of string being edited
End	Goes to the end of the string being edited

Assignable Shortcuts

Keyboard shortcuts can be programmed to control nearly every function on the 722. Shortcuts can select and change menu items with a simple key strokes. Combinations of computer keyboard function keys, along with Control-, Alt-, and Shift- can also be programmed. The following chart shows what keys are programmable.

Hot Key	Key	Shift-	Ctrl-	Alt-
F1-F12	X	X	X	X
0-9	-	-	X	X
A-Z	-	-	X	X
Logic In 1-6	X	-	-	-

To program a shortcut perform the following steps:

1. Enter the External Keyboard Assignment Setup Menu selection.

Shortcut number. Up to 50 shortcuts can be programmed

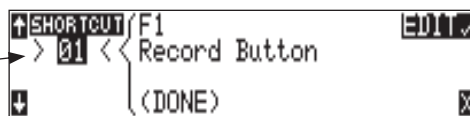

2. Select an unassigned shortcut number for programming. If a duplicate key sequence is selected the lowest shortcut number action takes place. The example below shows the F1 key being reprogrammed.



3. After selecting a key sequence select the desired Setup Menu item or action. The example below shows the reprogramming of the F1 key to change the sampling rate to 48048.

Specific Setup Menu options can be programmed if multiple options are available.

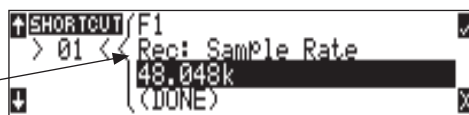

If a single key or key combination is programmed for multiple shortcuts, the shortcut with the lowest number will take precedence.

Shortcut List Functionality

The shortcut list is a user definable list of keyboard keys/Logic In that perform specified actions. The actions that a keyboard key can perform are listed in the below table. Macros are currently not implemented.

Action	Function
Momentary Button	Simulates selected button. Can simulate in any menu
Toggle Button	Toggles state of selected button. (Play & Record) are only supported
Open Menu	Opens a SetupUI Menu
Cycle Settings	Cycles a SetupUI parameter to the next setting and saves it
Set Settings	Sets a SetupUI parameter to the given setting and saves it
Open Time Code Menu	Opens the TimeCode: Jam Menu and goes to the given parameter
Jam Time Code Item	Jams given TimeCode parameter
Edit Time Code Item	Opens the TimeCode: Jam Menu Edit screen for the given parameter
Button Shortcuts	Simulates a front panel button shortcut. Ex: (Stop+Play) opens TakeList Menu

Logic Inputs and Outputs

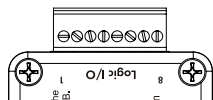

Identical to shortcuts assigned to computer keyboard key sequences, the CL-1 has six contacts that can be programmed to perform Setup Menu items or control the record, play, and stop functions of the recorder. A switch connected between the assigned pin and ground (pin-7) will form a circuit. Closing the circuit will activate the programmed action.

The Logic pins on the CL-1 can be set individually as either a switch-closure input or a switch closure output. The inputs and outputs are “logic low” devices, meaning that to turn “on” an input, it must be connected to ground (zero volts). Likewise, when an output is “on”, it puts out 0 volts and when it is “off”, it puts out +5 volts.

Logic Inputs

Configured as a switch-closure input, a pin can be connected to a switch that a user has wired to assigned contact. This switch can then trigger the 744T to begin recording. Other functions can be assigned as well from the Setup Menu. The switch-closure on a given pin of the CL-1 can be thought of as just another key on the keyboard. Anything that can be assigned to a key can also be assigned to a switch.

To configure a pin as an input, navigate to **Ext Keyboard Assign** in the Setup Menu. Select a new **Shortcut** number, then locate the Logic inputs amongst the assignable keys. Choosing **Logic In 1** would correspond to pin 1 on the CL-1, **Logic In 2** would correspond to pin 2 on the CL-1, and so on. After a Logic input is chosen assign the desired action that the Logic input will control.

Logic Outputs

Configured as a switch-closure output, the CL-1 can drive LEDs, relays, or any other sort of device which will accept a TTL-level or similar input. For example, the CL-1 can drive a big red LED connected via a series resistor between the +5V output and a switch-closure output and light up whenever the recorder is put into record mode.

To configure a pin as an output, go to **CL-1: Logic Out Assign** in the Setup Menu. The Logic Pin number is on the left hand side (“00”, “01”, etc). Each of these pins can be assigned to undefined, Stop, Play, Record, or Pause. Note that if a pin is assigned to be both an input (via the **Ext Keyboard Assign** Setup Menu) and an output (via the **CL-1: Logic Out Assign** Setup Menu), the pin will automatically default to an output.

Accessories

Included Accessories

The accessories below are included with the 722:

- XL-WPH worldwide (100–240 VAC to 12 VDC) power supply
- XL-B1 Li-ion rechargeable battery, 1500 mAh
- XL-14 headphone extension cable, 3.5 mm to 1/4-inch
- XL-MAN a nice man-bag
- XL-1394 - FireWire Power conditioner

Optional Accessories































The above accessories are just the start of building a flexible recording kit that can accommodate multiple types of connections. Available optional accessories to complete your recording kit include:

The above accessories are just the start of building a flexible recording kit that can accommodate multiple types of connections. Available accessories from Sound Devices include:

- **CL-1**
Remote Control and Keyboard Interface used to control the 744T with an external keyboard.
- **XL-DVDRAM**
An external bus-powered FireWire DVD Multi-drive. Based on the slot-loading Panasonic UJ-85 drive mechanism the XL-DVDRAM is used with a 7-Series recorder to record directly to optical disk or as a post-record storage volume.
- **CS-3**
Production bag with shoulder strap, holds 744T and is compatible with PortaBrace RM accessories; mounts onto CS-442, CS-302, and CS4W mixer bags
- **XL-1A (sold as pair)**
TA3F to TA3F cable, used to connect the direct outputs of the a Sound Devices 442 mixer to the channel 3/4 analog line-level inputs
- **XL-2 (sold as pair)**
TA3F to XLR-M cable, used for output connection from the master analog output
- **XL-2F (sold as pair)**
XLR-F to TA3F cable, used for input connection to line inputs 3 and 4 from balanced, XLR outputs.
- **XL-BNC**
BNC to BNC cable, to connect word clock from external sources to the 744T for synchronizing the 744T; also used to sync external devices from the word clock of the 744T.
- **XL-LB2**
5-pin LEMO to two (2) BNC, used to jam to and from video cameras.
- **XL-LL**
5-pin LEMO to 5-pin LEMO, used to connect the 744T time code circuit to Ambient time code sync boxes, slates, and controllers or to jam one 744T to another 744T; additionally used to jam Aaton cameras from the 744T
- **XL-LX**
5-pin LEMO to XLR-M and XLR-F, used to connect the time code output to SMTPE time code inputs and outputs
- **XL-B2**
removable, rechargeable, Li-ion battery; 4800 mAh battery; it's good to have several spares
- **XL-WPH**
power adapter included with unit; 100–240 VAC input, 12 VDC output; it's good to have a spare

Front Panel Button Shortcuts

To speed navigation the 7-Series has numerous navigation “shortcuts”. For combinations, hold down the first identified key and continue to hold while pressing the next keys.

Function	Key Sequence	Action
Record Tone	 + 	Record and Tone In the menu File: Marker Mode must be set to Markers Disabled. While recording hold the REC button and press the tone button. Tone will be active as long as the tone button is held.
Jam Menu	 + 	Menu and HDD Enters the time code jam menu. (702T & 744T Only)
Button Lock	 + 	Backlight and Tone Press backlight then tone to lock all front panel buttons except for Record, Stop and Play. FF and Rew are available in playback mode. Use backlight and tone again to unlock the panel.
Input Mutes		Input Hold down and press soft buttons to mute inputs
Input Routing	 + 	Stop and Input Hold down STOP and press INPUT to cycle through input routing presets. Last preset will open the input routing menu to the custom route selection
Phantom #1	 + 	Tone and Menu Toggles input 1 phantom power
Phantom #2	 + 	Tone and HDD Toggles input 2 phantom power
Low-cut #1	 + 	Backlight and Menu Toggles Input 1 high-pass filter
Low-cut #2	 + 	Backlight and HDD Toggles Input 2 high-pass filter
Connect FireWire	 + 	Stop and HDD Initiates FireWire connection if previously disconnected via an “eject” command
False Take	 + 	Stop and Rewind Delete last take prompt.
Increase Take	 + 	Stop and Fast Forward Increments take number to be recorded for next file
Take List	 + 	Stop and Play Take list and circle take identifying screen
Toggle Drives		HDD Hold the HDD button down for 1 second to toggle between viewable drives.
LED Level	 + Rotary Switch	Backlight and Rotary Switch Adjusts level of LED brightness.
Flashlight Mode	 +  + 	Rewind and Play and Stop With the power off, hold down these buttons while powering the unit to enter Flashlight mode. This illuminates all LEDs except for three. Press power again to exit.

Warranty and Technical Support

Warranty

Sound Devices, LLC warrants the 722 Portable Audio Recorder against defects in materials and workmanship for a period of ONE (1) year from date of original retail purchase. This is a non-transferable warranty that extends only to the original purchaser. Sound Devices, LLC will repair or replace the product at its discretion at no charge. Warranty claims due to severe service conditions will be addressed on an individual basis. THE WARRANTY AND REMEDIES SET FORTH ABOVE ARE EXCLUSIVE. SOUND DEVICES, LLC DISCLAIMS ALL OTHER WARRANTIES, EXPRESS OR IMPLIED, INCLUDING WARRANTIES OF MERCHANTABILITY AND FITNESS FOR A PARTICULAR PURPOSE. SOUND DEVICES, LLC IS NOT RESPONSIBLE FOR SPECIAL, INCIDENTAL, OR CONSEQUENTIAL DAMAGES ARISING FROM ANY BREACH OF WARRANTY OR UNDER ANY OTHER LEGAL THEORY. Because some jurisdictions do not permit the exclusion or limitations set forth above, they may not apply in all cases.

For all service, including warranty repair, please contact Sound Devices for an RMA (return merchandise authorization). Product returned without an RMA number may experience delays in repair.

Sound Devices, LLC
Service Repair RMA #XXXXX
300 Wengel Drive
Reedsburg, WI 53959 USA
telephone: (608) 524-0625

Technical Support

For technical support on all Sound Devices products, contact:

Sound Devices, LLC
E-mail: support@sounddevices.com
web: www.sounddevices.com/contact_support.htm
Telephone: +1 (608) 524-0625 / Toll-Free in the U.S.A.: (800) 505-0625
Fax: +1 (608) 524-0655

Sound Devices cannot guarantee that a given computer, software, or operating system configuration can be used satisfactorily with the 722 based exclusively on the fact that it meets the minimum system requirements.

CE Declaration of Conformity

According to ISO/IEC Guide 22

Sound Devices, LLC
300 Wengel Drive
Reedsburg, WI 53959 USA

declares that the product, 722 Professional Digital Audio Recorder is in conformity with and passes:

EN55103-1, 1997	EMC-product family standard for audio, video, audio-visual and entertainment lighting control apparatus for professional use. Part 1: Emissions
EN55103-2, 1997	EMC-product family standard for audio, video, audio-visual and entertainment lighting control apparatus for professional use. Part 2: Immunity
EN55103-1 Phenomena 2, 3, 1997	Magnetic emissions at 1 meter 50 Hz – 50 kHz
EN55103-2 Phenomena 3, 1997	Magnetic immunity 50 Hz to 10 kHz
CISPR 22 (EN55022) 2003	Radiated and conducted emissions, Class B
EN61000-4-2 (2001)/ IEC61000-4-2 (2001)	ESD, ± 4 kV contact, ± 8 kV air discharge
EN61000-4-3 (2001)/ IEC1000-4-3 (2001)	Radiated RF immunity, 10 V/m, 80% 1 kHz amplitude modulation
EN61000-4-4 (2001)/ IEC61000-4-4 (2001)	AC power ports: EFT Burst, I/O lines, ± 0.25 kV to ± 1.0 kV, power line ± 0.5 kV – ± 1 kV
EN61000-4-4 (2001)/ IEC61000-4-4 (2001)	EFT Burst, I/O lines, ± 0.25 kV to ± 1.0 kV, power line ± 0.5 kV – ± 1 kV
EN61000-4-5 (2001)/ IEC61000-4-5 (2001)	Surge ± 1 kV differential mode (line-to-line), ± 2 kV common mode (line-to-ground)
EN61000-4-6 (2001)/ IEC61000-4-6 (2001)	Conducted RF immunity, 3 V, 80% @1 kHz amplitude modulation
EN61000-4-11 (2002)/ IEC61000-4-11(2001)	Voltage dips and short interruptions at test voltage level: 0% V unominal @ 70% V unominal @ 25 period

Tested by L. S. Compliance, Inc. Cedarburg, Wisconsin

November 19, 2004

Matthew Anderson
Director of Engineering
Sound Devices, LLC

Software License

End-user license agreement for Sound Devices 7-Series Embedded Software / Firmware

Important Read carefully: This Sound Devices, LLC end-user license agreement (“EULA”) is a legal agreement between you (either an individual or a single entity) and Sound Devices, LLC for the Sound Devices, LLC software product identified above, which includes computer software, embedded software, and may include associated media, printed materials, and “online” or electronic documentation (“SOFTWARE PRODUCT”). By using, installing, or copying the SOFTWARE PRODUCT, you agree to be bound by the terms of this EULA. If you do not agree to the terms of this EULA, do not use or install the SOFTWARE PRODUCT.

Software Product License

The SOFTWARE PRODUCT is protected by copyright laws and international copyright treaties, as well as other intellectual property laws and treaties. The SOFTWARE PRODUCT is licensed, not sold.

Grant of license. This EULA grants you the following limited, non-exclusive rights: In consideration of payment of the licensee fee, Sound Devices, LLC, as licensor, grants to you, the licensee, a non-exclusive right to use this copy of a Sound Devices, LLC software program (hereinafter the “SOFTWARE”) on a single product and/or computer. All rights not expressly granted to licensee are reserved to Sound Devices, LLC.

Software ownership. As the licensee, you own the hardware on which the SOFTWARE is recorded or fixed. Sound Devices, LLC shall retain full and complete title to the SOFTWARE and all subsequent copies of the SOFTWARE, regardless of the media or form on or in which the original copies may exist. The license is not a sale of the original SOFTWARE.

Copyright. All rights, title, and copyrights in and to the SOFTWARE PRODUCT (including, but not limited to, any images, photographs, animations, video, audio, music, text, and “applets” incorporated into the SOFTWARE PRODUCT) and any copies of the SOFTWARE PRODUCT are owned by Sound Devices, LLC or its suppliers. The SOFTWARE PRODUCT is protected by copyright laws and international treaty provisions. Therefore, you must treat the SOFTWARE PRODUCT like any other copyrighted material, except that you may make copies as only provided below. You may not copy the printed materials accompanying the SOFTWARE PRODUCT.

Restrictions on use. Licensee may not distribute copies of the SOFTWARE or accompanying materials to others. Licensee may not modify, adapt, translate, reverse engineer, decompile, disassemble, or create derivative works based on the SOFTWARE or its accompanying printed or written materials.

Transfer restrictions. Licensee shall not assign, rent, lease, sell, sublicense, or otherwise transfer the SOFTWARE to another party without prior written consent of Sound Devices, LLC. Any party authorized by Sound Devices, LLC to receive the SOFTWARE must agree to be bound by the terms and conditions of this agreement.

Termination. Without prejudice to any other rights, Sound Devices, LLC may terminate this EULA if you fail to comply with the terms and conditions of this EULA. In such event, you must destroy all copies of the SOFTWARE PRODUCT and all of its component parts.

Limited Warranty

No warranties. Sound Devices, LLC expressly disclaims any warranty for the SOFTWARE PRODUCT. The SOFTWARE PRODUCT and any related documentation is provided “as is” without warranty or condition of any kind, either express or implied, including, without limitation, the implied warranties and conditions of merchantability, fitness for a particular purpose, or non-infringement. The entire risk arising out of use or performance of the SOFTWARE PRODUCT remains with you.

No liability for damages. In no event shall Sound Devices, LLC or its suppliers be liable for any damages whatsoever (including, without limitation, damages for loss of business profits, business interruption, loss of business information, or any other pecuniary loss) arising out of the use of or inability to use this Sound Devices, LLC product, even if Sound Devices, LLC has been advised of the possibility of such damages. In any case, Sound Devices, LLC’s entire liability under any provision of this evaluation license shall be limited to the greater of the amount actually paid by you for the SOFTWARE PRODUCT or U.S. \$5.00. Because some states/jurisdictions do not allow the exclusion or limitation of liability for consequential or incidental damages, the above limitation may not apply to you.

Governing Law

This agreement and limited warranty are governed by the laws of the state of Wisconsin.

SOUND **DEVICES**