

BD-2 Blues Driver

Owner's Manual

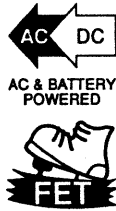
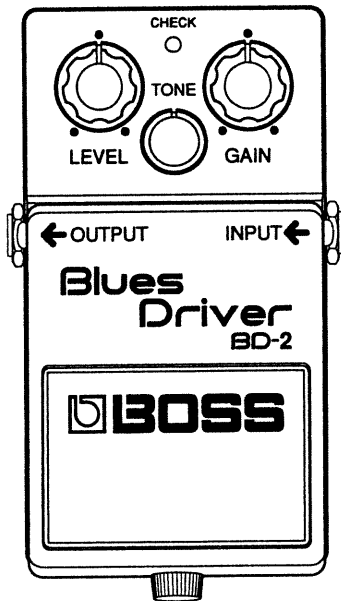

Thank you, and congratulations on your choice of BOSS BD-2 Blues Driver. To ensure proper operation, and years of trouble-free service, please take the time to read through this Owner's Manual before starting out.

FEATURES

The BD-2 is the overdrive that has been specifically designed for crunch distortion.

It can faithfully express the tone change caused by moving the knobs on the guitar.

It can create distortion that can faithfully reproduce the picking nuance of the player.

It can create wide varieties of distortions from crunch to hard distortion, by adjusting the Gain Knob.

Even if the Gain Knob is raised, a clean and natural sound can be produced by turning the volume of the guitar.

A natural-sounding overdrive continues to be produced without any loss in its quality, even if you turn down the volume on your guitar.

© 1995 BOSS Corporation

All right reserved. No part of this publication may be reproduced in any form without the written permission of BOSS Corporation.

2

IMPORTANT NOTES

When using an AC adaptor, use only the specified device (PSA Series). Use of any other AC adaptor could result in damage, malfunction or electric shock.

POWER SUPPLY

The power requirement for this unit is indicated on its nameplate (rear panel). Ensure that the voltage in your installation meets this requirement.

If the unit is to remain unused for an extended period of time, unplug the power cord.

PLACEMENT

Do not subject the unit to temperature extremes (eg., direct sunlight in an enclosed vehicle). Avoid using or storing the unit in dusty or humid areas, or areas that are subject to high levels of vibration.

ADDITIONAL PRECAUTIONS

Protect the unit from strong impact.

Should a malfunction occur, or if you suspect there is a problem, discontinue use immediately. Contact qualified service personnel as soon as possible.

To avoid the risk of electric shock, do not open the unit.

CHANGING BATTERY

Remove the battery whenever the unit is to remain unused for an extended period of time.

PANEL DESCRIPTIONS

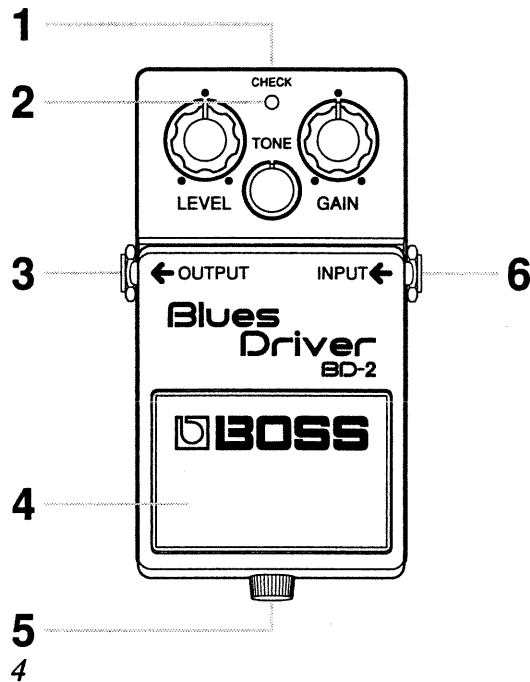

1. AC Adaptor Jack

Accepts connection of an AC Adaptor (optionally available BOSS PSA-Series). By using an AC Adaptor, you can play without being concerned about how much battery power you have left.

** You may find that it is a good idea to keep a battery installed in the unit even while using an adaptor. That way your playing won't be disrupted even if the adaptor is accidentally disconnected.*

** If you are going to use an AC adaptor, be sure to use the specified unit (BOSS PSA-Series). Use of any other adaptor may result in damage, malfunction or electric shock. Also, if you are not going to be using it for an extended period of time, disconnect the AC adaptor from the AC outlet.*

2. CHECK Indicator

This indicator shows whether an effect is ON/OFF, and also doubles as the Battery Check indicator.

The indicator lights when an effect is ON. If this indicator goes dim or no longer lights while an effect is ON, the battery is near exhaustion and should be replaced immediately.

3. OUTPUT Jack

The output jacks are used to connect the unit to amplifiers or other devices.

4. Pedal Switch

This switch turns the effects ON/OFF.

5. Thumbscrew

This thumbscrew is loosened to open the pedal, allowing battery replacement. For instructions on how to replace the battery, please refer to "CHANGING THE BATTERY."

6. INPUT Jack

This jack accepts input signals (coming from a guitar, some other musical instrument, or another effects unit).

** The INPUT jack also serves as the power switch. Power is turned on whenever a plug is inserted into the INPUT jack, and is turned off when the plug is disconnected. When not using the unit, you should disconnect any cord connected to the INPUT jack.*

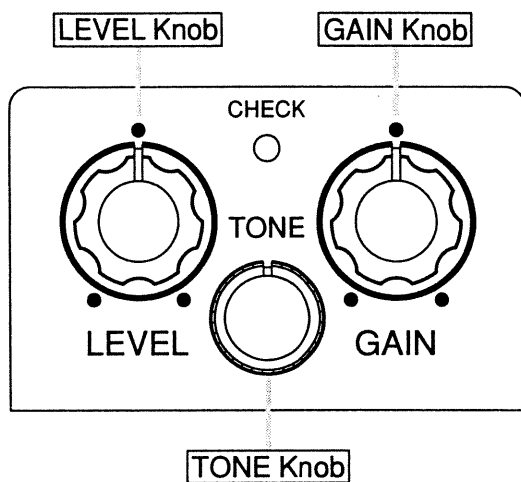

LEVEL Knob

This adjusts the volume of the effect sound.

** When this knob is turned counterclockwise, no sound will be heard.*

TONE Knob

This adjusts the tone of sound. Rotating it clockwise will create sharp sound with emphasized treble, while turning it counterclockwise will create soft sound with cut treble.

GAIN Knob

This adjusts the gain of the blues driver. Rotating the knob clockwise will increase the gain creating harder distortion.

6

MAKING THE CONNECTIONS

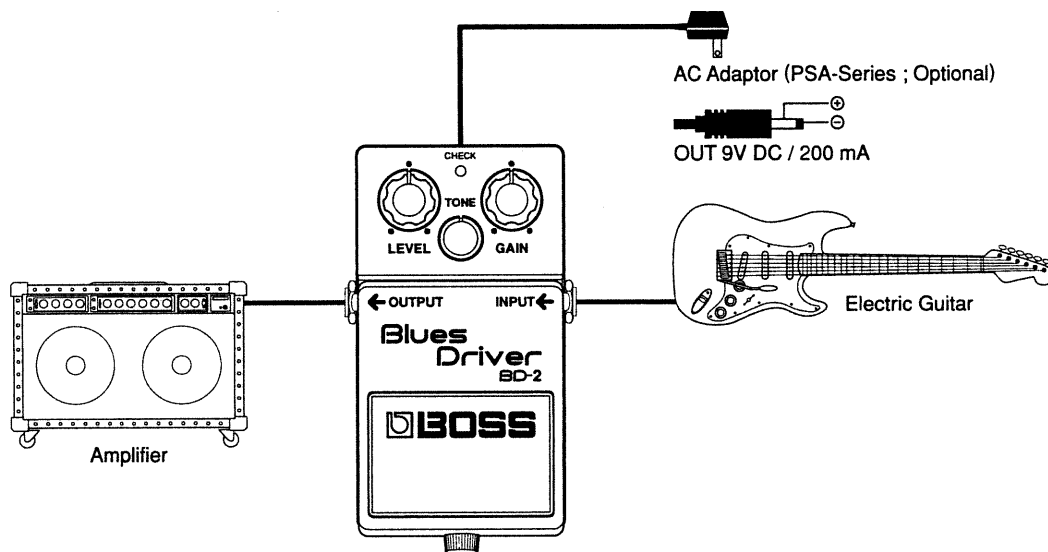

** Inserting a plug into the Input Jack will automatically switch the unit on.*

** Before connecting or disconnecting any patch cords, be sure all the volume controls in your system are set to minimum. This will help prevent any damage to system components.*

OPERATING THE UNIT

1. When you have made the necessary connections, set the knobs as shown in the illustration.
2. Depress the pedal switch to turn the effect on. (Make sure that the CHECK Indicator lights.)
3. Adjust the gain of the Dry or Overdrive sound using the GAIN Knob.

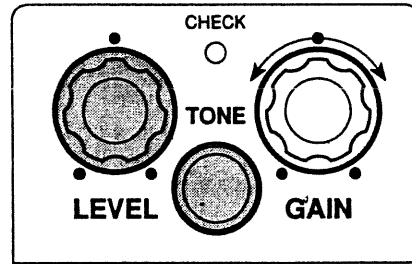
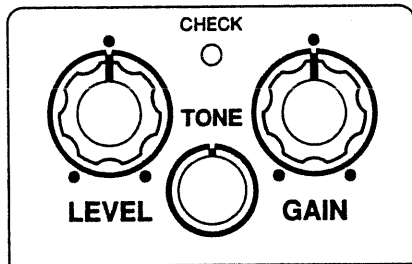

8

4. Adjust the tone using the TONE Knob.
5. Adjust the LEVEL Knob so there will be no volume difference between the effect and straight bass sounds.

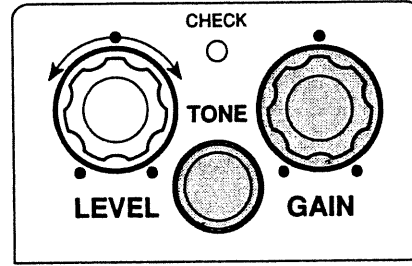
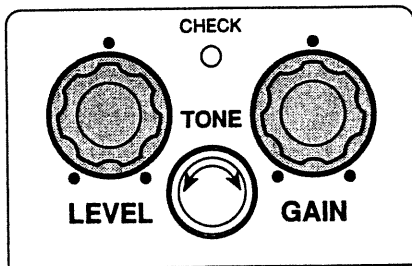

9

CHANGING THE BATTERY

When the indicator goes dim or no longer lights while an effect is on, it means that the battery is nearly dead and must be replaced.

Replace the battery following the steps below.

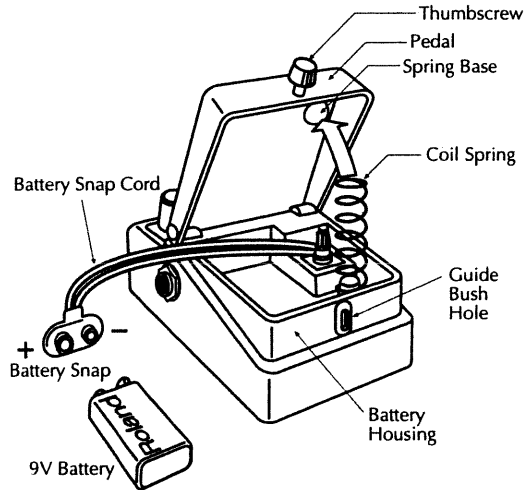

10

1. Loosen the thumbscrew at the front of the pedal, then lift the pedal upwards to open the unit.

** The thumbscrew can be left in the pedal while changing the battery.*

2. Remove the old battery from the battery housing, and remove the snap cord connected to it.

3. Connect the snap cord to the new battery, and place the battery inside the battery housing.

** Be sure to carefully observe the battery's polarity (+ versus -).*

4. Slip the coil spring onto the spring base on the back of the pedal, then close the pedal.

** Carefully avoid getting the snap cord caught in the coil spring.*

5. Finally, insert the thumbscrew into the guide bush hole and fasten it securely.

SAMPLE SETTING

Crunch

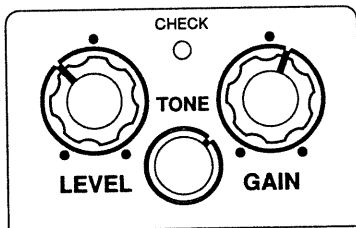

British Blues

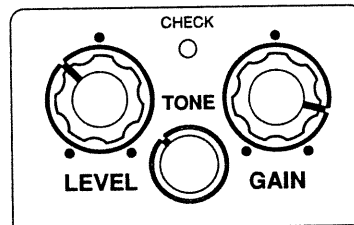

American Blues

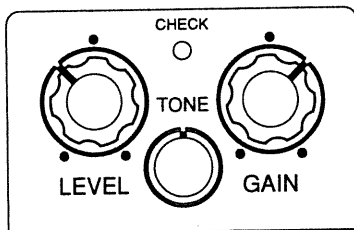

Booster

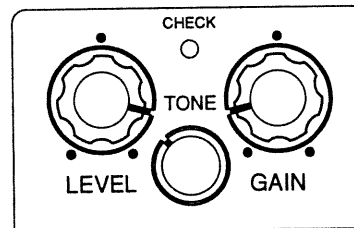

11

OverDrive

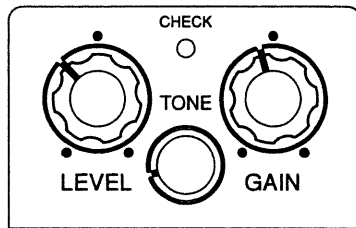

Turbo OverDrive

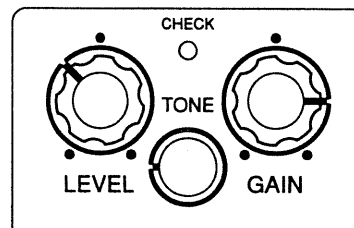

Chord Play

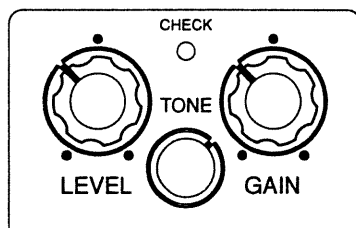

Clean Crunch

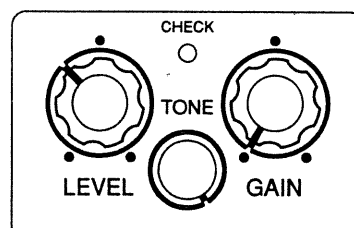

12

SETTING MEMO

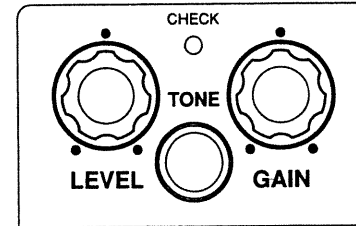
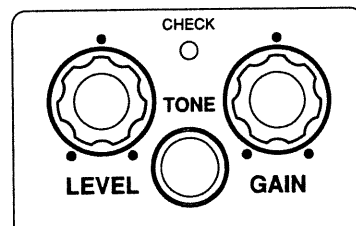
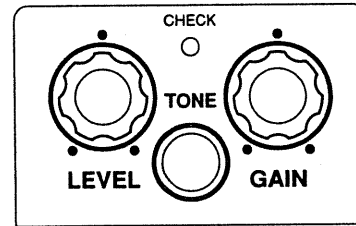
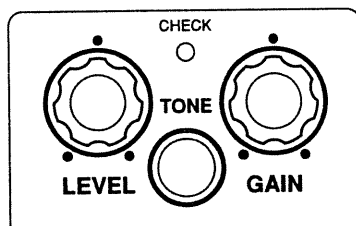

13

SPECIFICATIONS

BD-2 : Blues Driver

Nominal Input Level	-20 dBm
Input Impedance	1 M Ω
Nominal Output Level	-20 dBm
Output Impedance	1 k Ω
Equivalent Input Noise Level	-118 dBm (IHF-A, Typ.)
Controls	Pedal Switch, LEVEL Knob, TONE Knob, GAIN Knob
Indicator	CHECK Indicator (serves also as battery check indicator)
Connectors	INPUT Jack, OUTPUT Jack, AC Adaptor Jack (9 V DC)
Power Supply	9 V DC : Dry Battery 9 V type (6F22/9 V), AC Adaptor
Current Draw	13 mA (9 V DC)

*** Expected battery life under continuous use :**

Carbon : 20 hours

These figures will vary depending on the actual conditions of use.

14

Dimensions	70 (W) x 125 (D) x 55 (H) mm 2-3/4 (W) x 4-15/16 (D) x 2-3/16 (H) inches
Weight	400 g / 15 oz (including battery)
Accessories	Owner's Manual, Dry Battery 9 V type (6F22/9 V)
Options	AC Adaptor PSA-Series

*** 0 dBm = 0.775 V rms**

*** In the interest of product development, the specifications and/or appearance of this unit are subject to change without prior notice.**

15



 Roland®

00786134

UPC

00786134



18981

 **BOSS**