

# **BOSS** **CE-5** Chorus Ensemble

## Instructions

Thank you for purchasing the BOSS CE-5 Chorus Ensemble. To make the best use of the CE-5, please read the instructions carefully.

- The CE-5 features two band filters that allow individual control of the bass and treble frequencies.
- By using two band filters, you can create various chorus effects, such as a chorus with a narrow frequency band, or a sharp chorus stretched to the upper frequency range.
- By cutting the lower frequency range using the Low Filter Control Knob, you can obtain a natural chorus effect with minimal sound interference between the direct signals and the processed signals.
- Two channel output jacks serve for creating deep chorus effects with the space synthesis system.

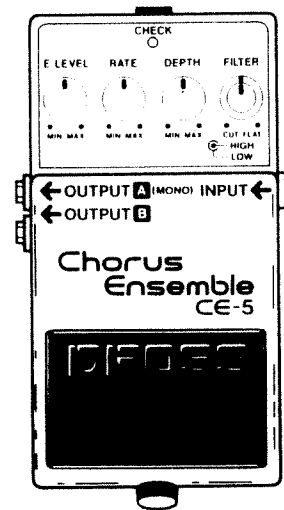

## ■ CAUTION

- \* Inserting a plug into the INPUT Jack will automatically switch the unit on.
- \* To prevent malfunction and/or damage to speakers or other devices, always turn down the volume, and turn off the power on all devices before making any connections.
- \* If there are batteries in the unit while an AC adaptor is being used, normal operation will continue should the line voltage be interrupted (power blackout or power cord disconnection).
- \* Once the connections have been completed, turn on power to your various devices in the order specified. By turning on devices in the wrong order, you risk causing malfunction and/or damage to speakers and other devices.  
When powering up: Turn on the power to your guitar amp **last**.  
When powering down: Turn off the power to your guitar amp **first**.
- \* Always make sure to have the volume level turned down before switching on power. Even with the volume all the way down, you may still hear some sound when the power is switched on, but this is normal, and does not indicate a malfunction.
- \* When operating on battery power only, the unit's indicator will become dim when battery power gets too low. Replace the battery as soon as possible.
- \* The CHECK indicator shows whether the effect is being applied or not. It does not indicate whether the power to the device is on or not.

# BOSS CE-5

Chorus Ensemble

## Instructions

Thank you for purchasing the BOSS CE-5 Chorus Ensemble. To make the best use of the CE-5, please read the instructions carefully.

- The CE-5 features two band filters that allow individual control of the bass and treble frequencies.
- By using two band filters, you can create various chorus effects, such as a chorus with a narrow frequency band, or a sharp chorus stretched to the upper frequency range.
- By cutting the lower frequency range using the Low Filter Control Knob, you can obtain a natural chorus effect with minimal sound interference between the direct signals and the processed signals.
- Two channel output jacks serve for creating deep chorus effects with the space synthesis system.

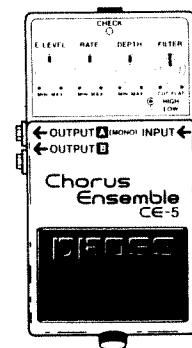

## ■ PANEL DESCRIPTION

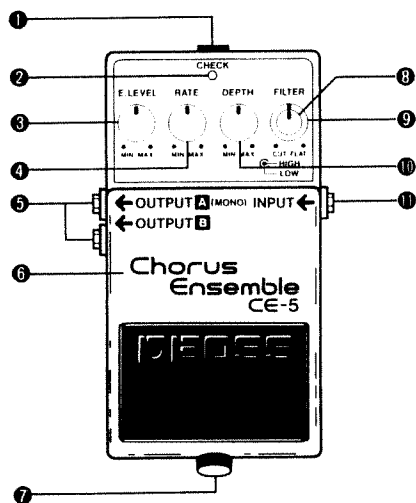

### ① AC Adaptor Jack

Connect an AC adaptor ( BOSS PSA-120, 220 or 240 depending on the line voltage system in your country ) to this jack.

- \* An AC adaptor allows long and secure operation without worrying about battery life.
- \* Be sure to use a BOSS PSA-120, 220 or 240 adaptor.
- Use of any other adaptor may damage the device.

### ② Check Indicator

This indicator lights when the effect is turned on, and therefore, can be used as an effect on/off indicator.

- \* The Check Indicator also serves as a battery check. When it becomes dim or does not light at all, battery replacement is required.

### ③ Effect Level Control Knob

This knob adjusts the level of the effect sounds. Clockwise rotation increases the level of the effect sound and counterclockwise rotation decreases it.

### ④ Modulation Rate Control Knob

This knob adjusts the speed of the chorus effect. Clockwise rotation increases the rate and counterclockwise rotation decreases it.

### ⑤ Output Jacks A/B

Connect an amplifier or other effect units to these jacks.  
For monaural output, use Output Jack A.

### ⑥ Pedal Switch

Pressing the pedal turns the effect on or off.

### ⑦ Thumb Screw

Loosen the screw to open the cover for battery replacement.  
( For a detailed explanation of battery replacement, see "BATTERY REPLACEMENT". )

### ⑧ High Filter Control Knob

This knob controls the treble frequencies of the chorus sound. Rotating this knob clockwise widens the output band while rotating it counterclockwise narrows it.

### ⑨ Low Filter Control Knob

This knob controls the bass frequencies of the chorus sound. Rotating this knob clockwise widens the output band while rotating it counterclockwise narrows it.

### ⑩ Modulation Depth Control Knob

This knob controls the depth of chorus effect. Clockwise rotation deepens the effect while counterclockwise rotation creates the shallower effect.

### ⑪ Input Jack

Connect an electric or electronic musical instrument (such as an electric guitar) to this jack.  
\* Connecting an instrument to this jack will automatically switch the unit on. Be sure to disconnect the cord from this jack when the unit is not being used.

## CONNECTIONS

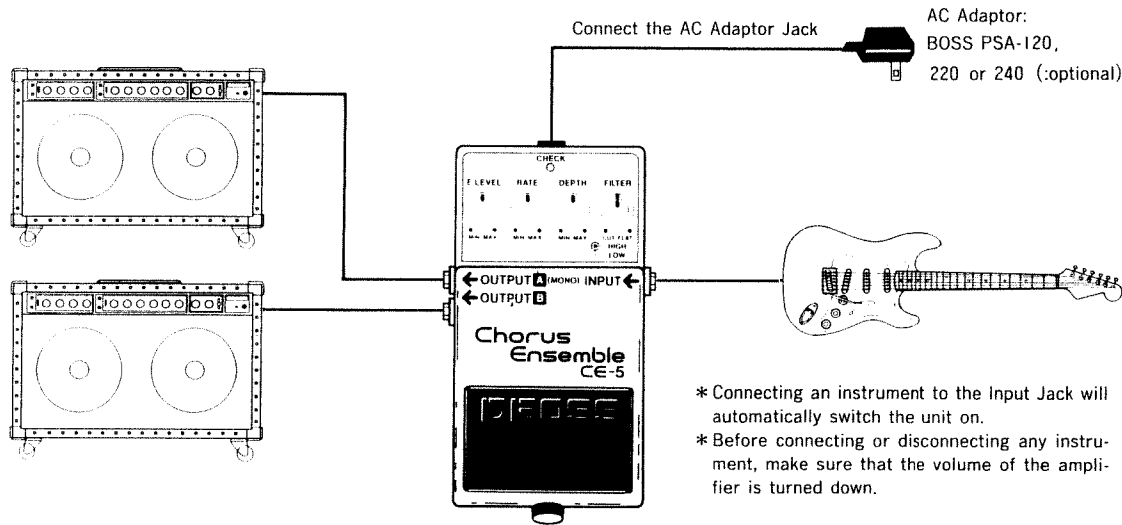

\* For monaural output, use Output Jack A. Both the dry and processed signals are output.

\* For stereo use:

Output A : Only the processed signal (pitch modulated sound) is output. The dry (unprocessed) signal is not output.

Output B : Only the dry signal is output.

The CE-5 adopts the "space synthesis system" for stereo output. That is, the depth of the effect varies depending on the distance between speakers. Note that lowering a filter control knob or effect level too much will shift the sound image to the Output B position, and therefore diminish the effect. Experiment with different as you play the instrument.

\* When you use a high output guitar, the sound may be distorted. If distortion occurs, turn down the volume of the guitar or use a limiter, etc.

## OPERATION

① Make all the necessary connections, then set the controls on the panel as shown below.

\* Before connecting or disconnecting any instrument, make sure that the volume of the amplifier is turned down.

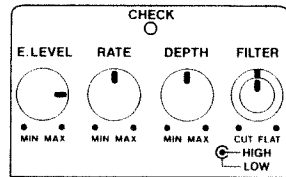

③ Adjust the rate of the effect using the Modulation Rate Control Knob ④.

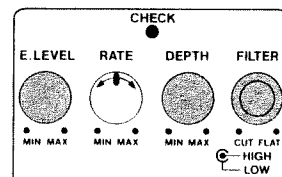

⑤ Using the High Filter Control Knob ⑧ and the Low Filter Control Knob ⑨, adjust the tone of the effect sound.

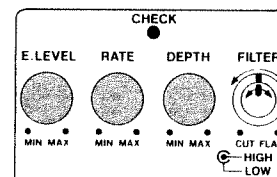

② Press the Pedal Switch ① to turn the effect on. ( Make sure the Check Indicator lights up. )

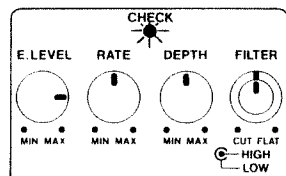

④ Adjust the depth of the chorus effect using the Modulation Depth Control Knob ⑩.

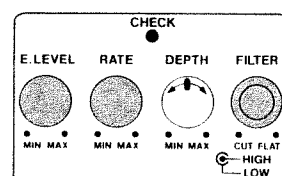

⑥ Adjust the volume of the processed sound using the Effect Level Control Knob ③.

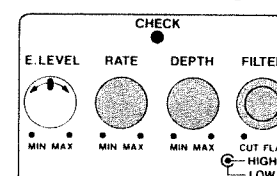

## ■ SPECIFICATIONS

Controls .....	Pedal Switch, Effect Level, Modulation Rate, Modulation Depth, High Filter, Low Filter
Indicator .....	Check Indicator (serves also as battery check indicator)
Jacks .....	Input, Output A(MONO)/B, AC Adaptor
Input Impedance .....	1 MΩ
Output Impedance .....	1 kΩ
Recommended Load Impedance .....	10 kΩ or greater
Residual Noise .....	-93 dBu or less (IHF-A, Typ.) (Filter Control knob; center)
Power Supply .....	DC 9 V; Dry battery (6F22/9V), AC Adaptor (PSA-series)
Current Draw .....	22 mA (DC 9 V)
Dimensions .....	73 (W) x 129 (D) x 59 (H) mm 2-7/8 (W) x 5-1/8 (D) x 2-3/8 (H) inches
Weight .....	410 g / 0.9 lbs (including battery)
Accessories .....	Instructions, Dry Battery; 6F22/9V (Carbon), Leaflet ("USING THE UNIT SAFELY," "IMPORTANT NOTES," and "Information")
Options .....	AC Adaptor PSA-Series

\* 0 dBu = 0.775 Vrms

\* In the interest of product improvement, the specifications and/or appearance of this unit are subject to change without prior notice.

Copyright © BOSS CORPORATION  
All rights reserved. No part of this publication may be reproduced in any form without the written permission of BOSS CORPORATION.

**BOSS**<sup>®</sup>  
BOSS Corporation

2604776703 Printed in Taiwan 2003-3-D3-4C



For EU Countries  
This product complies with the requirements of European Directive 89/336/EEC.

For the USA

### FEDERAL COMMUNICATIONS COMMISSION RADIO FREQUENCY INTERFERENCE STATEMENT

This equipment has been tested and found to comply with the limits for a Class B digital device, pursuant to Part 15 of the FCC Rules. These limits are designed to provide reasonable protection against harmful interference in a residential installation. This equipment generates, uses, and can radiate radio frequency energy and, if not installed and used in accordance with the instructions, may cause harmful interference to radio communications. However, there is no guarantee that interference will not occur in a particular installation. If this equipment does cause harmful interference to radio or television reception, which can be determined by turning the equipment off and on, the user is encouraged to try to correct the interference by one or more of the following measures:

- Reorient or relocate the receiving antenna.
- Increase the separation between the equipment and receiver.
- Connect the equipment into an outlet on a circuit different from that to which the receiver is connected.
- Consult the dealer or an experienced radio/TV technician for help.

This device complies with Part 15 of the FCC Rules. Operation is subject to the following two conditions:

- (1) This device may not cause harmful interference, and
- (2) This device must accept any interference received, including interference that may cause undesired operation.

Unauthorized changes or modification to this system can void the users authority to operate this equipment. This equipment requires shielded interface cables in order to meet FCC class B Limit.

For Canada

#### NOTICE

This Class B digital apparatus meets all requirements of the Canadian Interference-Causing Equipment Regulations.

#### AVIS

Cet appareil numérique de la classe B respecte toutes les exigences du Règlement sur le matériel brouilleur du Canada.

## ■ SAMPLE SETTINGS

Clear chorus sound with minimal sound interference.

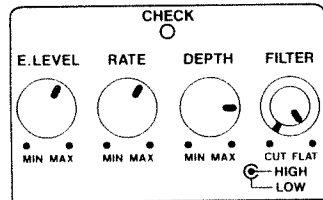

Contemporary chorus sound with wide frequency characteristic.

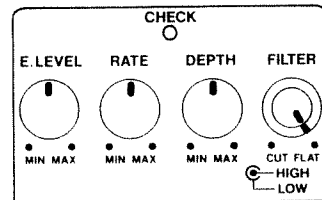

One-time chorus sound with a narrow frequency characteristic.

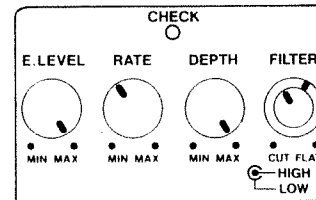

Vibration Sound

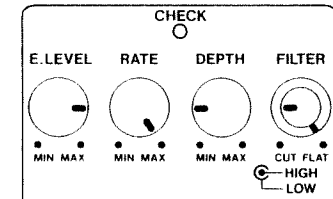

Discreet chorus sound with slight spaciousness.

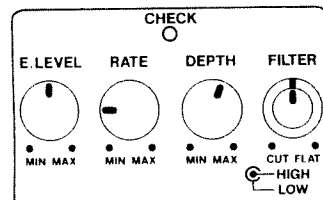

The deepest and fattest chorus sound.

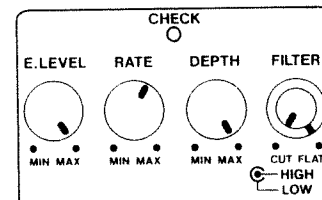

For Arpeggio

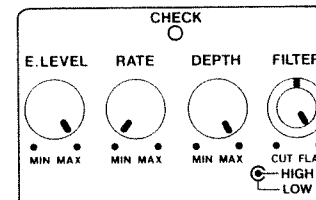

Setting for stereo output ( with spontaneous Depth and Rate settings ).

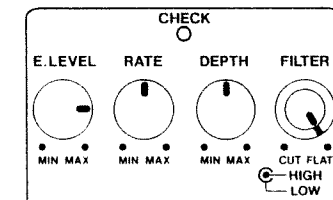

## ■ BATTERY REPLACEMENT

- ① Loosen the thumb screw on the pedal to open it.
- ② Take out the battery from the battery housing and disconnect the battery snap.
- ③ Connect a new battery to the battery snap, then replace the battery in to the battery housing.
  - \* Make sure that the polarity of the battery is correct.
- ④ Push the coil spring into the spring base on the rear of the pedal, then close the pedal.
  - \* Make sure that the snap cord is not caught in the pedal or coil spring.
- ⑤ Insert the thumb screw into the guide bush hole and firmly tighten the screw.

### Use one 9-volt battery

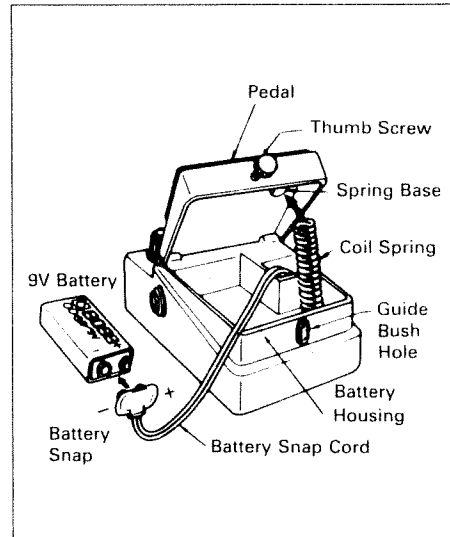

## ■ IMPORTANT NOTES

- Do not subject the unit to temperature extremes (eg. direct sunlight in an enclosed vehicle). Avoid using or storing the unit in dusty or humid areas or areas that are subject to high vibration levels.
- Remove the battery whenever the unit is not going to be used for an extended period of time.
- When operating solely on a battery, the unit's indicator becomes dim when the battery is depleted. Replace the battery immediately.
- If there is a battery in the unit while an AC adaptor is being used, normal operation will continue should the line voltage be interrupted (power blackout) or the power cord become disconnected.
- Should a malfunction occur (or if you suspect there is a problem) discontinue use immediately. Contact

qualified service personnel as soon as possible.

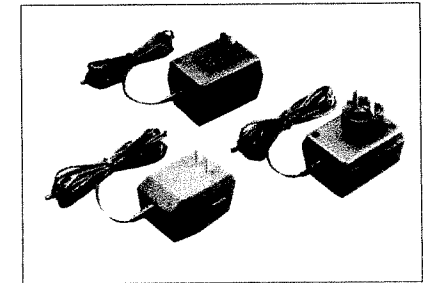

● OUT: 9VDC/200mA

## SETTING MEMO

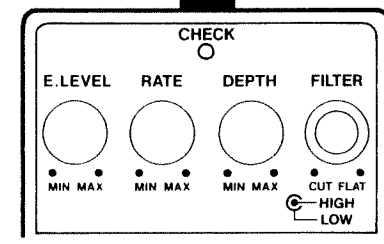
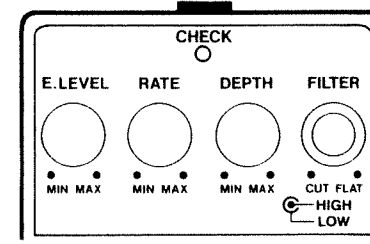
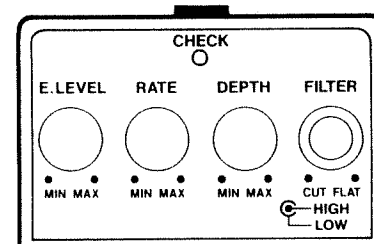
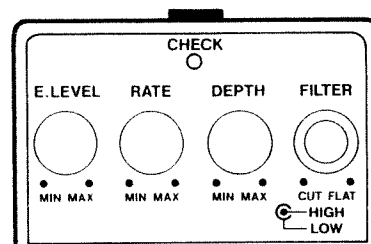
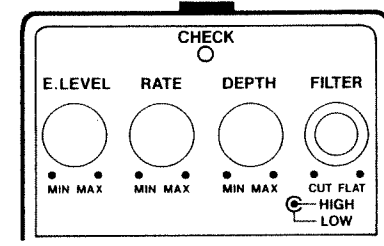
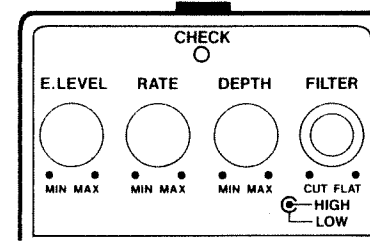
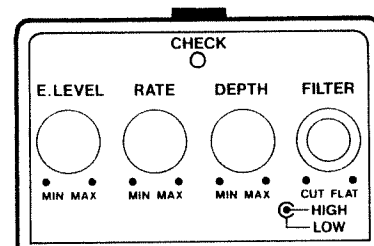
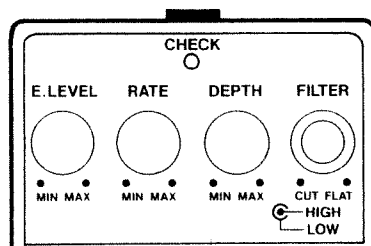

 Roland®

---

**26047767RT**

UPC

26047767RT



18981

 **BOSS**