

## ■ SPECIFICATIONS

**Power Supply:** 9V DC battery, 6F22(X1); AC Adaptor (PSA series)

**Current Draw:** 12mA (9V DC)

**Controls:** Color, Drive, Tone, Level

**Switch:** Effect On/Off

**Indicator:** Effect On/Off (serves also as battery check indicator)

**Jacks:** Input, Output, AC Adaptor

**Equivalent Input Noise:** Less than -100dBm (IHF-A)

**Input Impedance:** 1MΩ

**Output Load Impedance:** More than 10kΩ

**Dimensions:** 70 (W) x 55 (H) x 125 (D) mm  
2-3/4" x 2-3/16" x 4-15/16"

**Weight:** 400g/14oz.

\* Specifications are subject to change without notice.

**BOSS**  
Products of Roland

2603798100

Printed in Taiwan '90-3-E3-11Y

# BOSS OS-2 Over Drive/ Distortion

## INSTRUCTIONS

Thank you, and congratulations on your choice of this product. To make sure you get the most out of the OS-2 OVERDRIVE/DISTORTION, and enjoy continuing satisfaction as a result of operating it under the best of conditions, please thoroughly read these instructions.

- Overdrive and distortion have been combined into one compact effects unit.
- You are provided with a wealth of new sound creation possibilities as a result of the mixture of overdriven and distorted sounds.
- The unit is equipped with a Color knob which allows you to adjust at will the respective portions included in the sound mixture.
- A overdrive that really sounds like it comes from a large-scale tube amp is created as a result of the unique BOSS "Asymmetrical Overdrive Circuitry" that is incorporated in the unit.

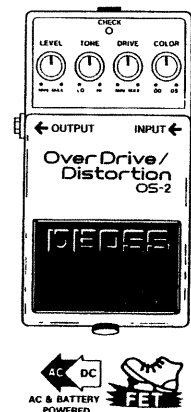

## ■ PANEL DESCRIPTION

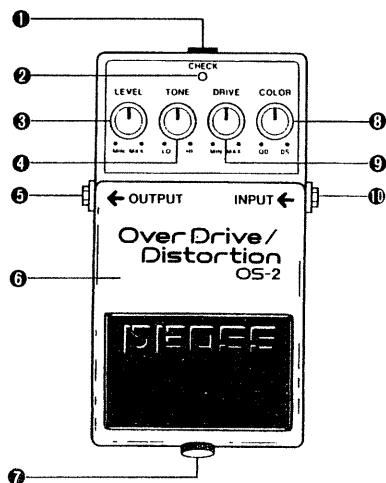

### ① AC Adaptor Jack

This jack accepts connection of the AC Adaptor (BOSS PSA-120,220 or 240; optional).

\* Use of the AC adaptor allows you to play for as long as you wish without being concerned about the battery wearing out.

\* Make certain you use only the specified AC adaptor (PSA series). Use of any other AC adaptor can cause operational errors or damage to the unit.

### ② Check Indicator

Lights up when the effect is on, allowing you to confirm if effect is on or off.

\* This indicator also serves as the Battery Check indicator. When it becomes dim, or no longer lights, this means that the battery has been depleted and needs to be replaced with a new one.

### ③ Level Knob

Adjusts the level of the sound when the effects are applied. It should be adjusted so that there is no difference between when effects are on and when they are off.

[↻]: The volume of that when effects are applied becomes greater.

[↺]: The volume of that when effects are applied is reduced. When turned fully counterclockwise (↺) no sound at all will be output.

### ④ Tone Knob

Adjusts the tone of the effected sound.

[↺]: The sound becomes sharper, with more emphasis placed on the upper range.

[↻]: The sound becomes softer, since the upper range is cut.

### ⑤ Output Jack

This output jack is used for connecting with an amplifier or other effects devices.

### ⑥ Pedal Switch

Used to turn effects on or off.

### ⑦ Thumb Screw

When this screw is loosened, the pedal opens, allowing for the battery to be changed. For information on how to change the battery, refer to "BATTERY REPLACEMENT"

\* The screw should not be removed completely from the pedal. If it should come off, make sure you do not misplace it.

### ⑧ Color Knob

Adjusts the balance between the overdrive and

distortion.

[↺]: The proportion of the distorted sound is increased.

[↻]: The proportion of the overdriven sound is increased.

\* When the knob is turned to one or the other extreme, you obtain solely either the distortion or the overdrive effect.

### ⑨ Drive Knob

Adjusts the degree to which the overdrive/distortion will be applied.

[↺]: The distortion becomes greater, providing a truly heavy sound.

[↻]: The distortion is reduced.

### ⑩ Input Jack

This jack accepts connection of a guitar or other electronic instruments and devices.

\* The Input jack is equipped with a power switch. When a plug is inserted into it, the power is turned on; and when the plug is pulled out, the power is turned off. When the unit is not being used, any cord connected to the Input jack should be disconnected.

## CONNECTIONS

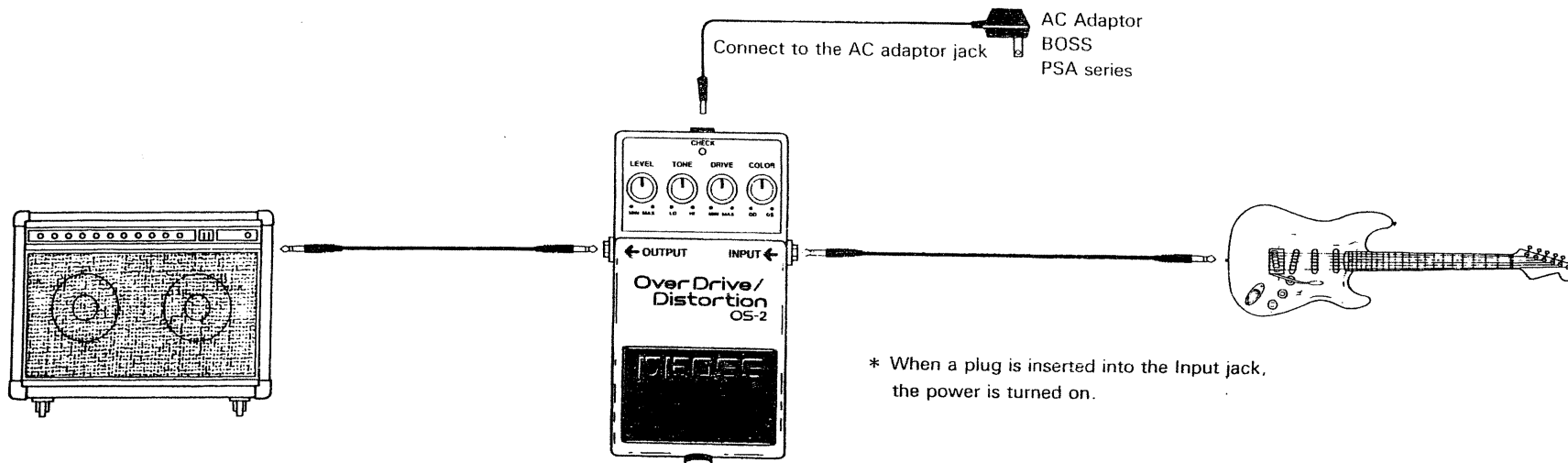

## OPERATION

① Once you have all cords connected, the knobs on the panel should be set as shown in the illustration.

\* Always make sure you turn down the volume on your amplifier before connecting or disconnecting any cords.

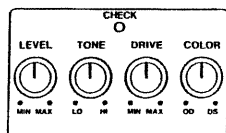

② Depress the pedal switch ⑥, thus turning the effect on.

(The Check Indicator will light up.)

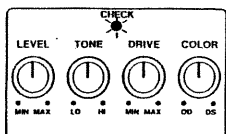

③ Using the Color knob ① adjust the balance between the distortion and the overdrive. When turned clockwise, the distorted sound proportion is increased. When turned counterclockwise, the overdriven sound proportion is increased. When the knob is turned to one or the other extreme, you obtain solely either the distortion or the overdrive effect.

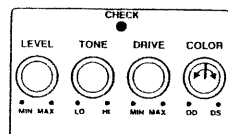

④ Using the Drive knob ② adjust the degree to which the effect is to be applied. The further it is moved clockwise, the greater the distortion becomes.

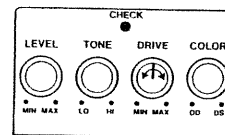

⑤ Using the Tone knob ④, adjust the tone of the sound heard when the effect is on. The further it is moved clockwise, the more the upper range is enhanced, and the sharper the sound becomes.

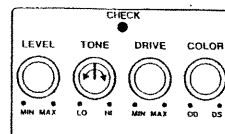

⑥ Using the Level knob ③, adjust the volume of what is heard when the effect is on. It should be adjusted so there is no difference in volume between when the effect is on and when it is off.

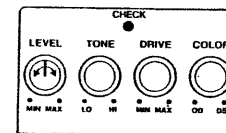

## ■ BATTERY REPLACEMENT

- ① Loosen the thumb screw on the pedal to open it.
- ② Take out the battery from the battery housing and disconnect the battery snap.
- ③ Connect a new battery to the battery snap, then replace the battery in to the battery housing.  
\* Make sure that the polarity of the battery is correct.
- ④ Push the coil spring into the spring base on the rear of the pedal, then close the pedal.  
\* Make sure that the snap cord is not caught in the pedal or coil spring.
- ⑤ Insert the thumb screw into the guide bush hole and firmly tighten the screw.

### Use one 9-volt battery

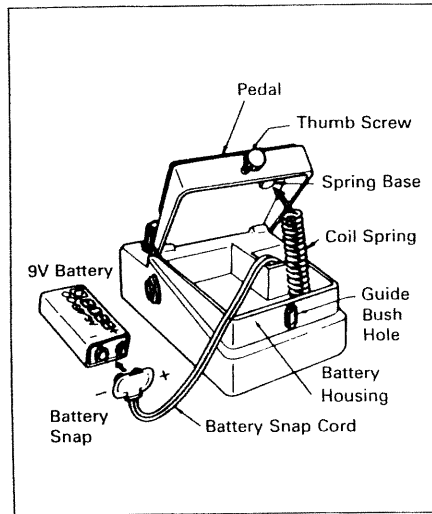

## ■ IMPORTANT NOTES

- Do not subject the unit to temperature extremes (eg. direct sunlight in an enclosed vehicle). Avoid using or storing the unit in dusty or humid areas or areas that are subject to high vibration levels.
- Remove the battery whenever the unit is not going to be used for an extended period of time.
- When operating solely on a battery, the unit's indicator becomes dim when the battery is depleted. Replace the battery immediately.
- If there is a battery in the unit while an AC adaptor is being used, normal operation will continue should the line voltage be interrupted (power blackout) or the power cord become disconnected.
- Should a malfunction occur (or if you suspect there is a problem) discontinue use immediately. Contact

qualified service personnel as soon as possible.

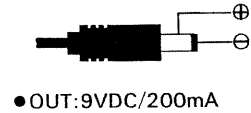
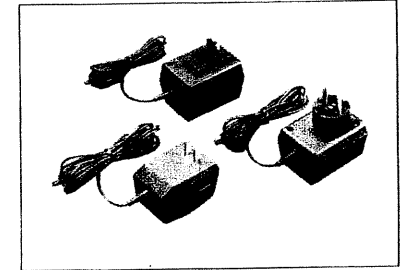

## SETTING MEMO

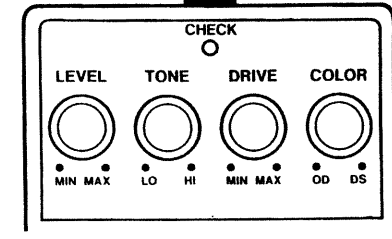
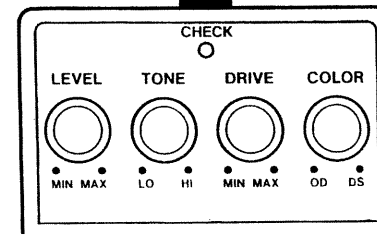
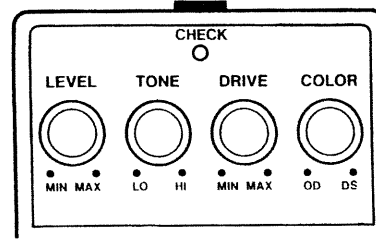
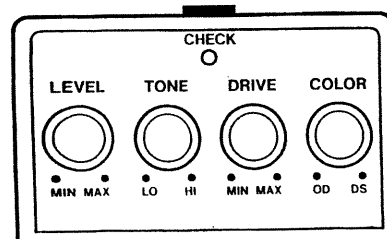
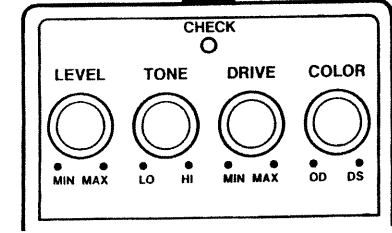
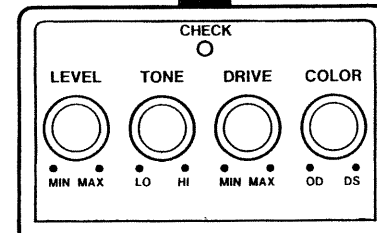
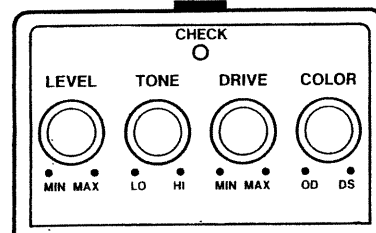
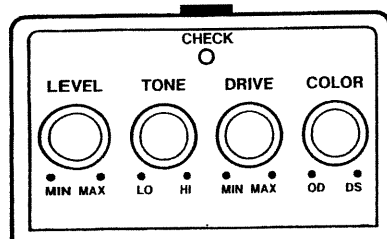

 Roland®

2603798100

UPC

2603798100



18981

 **BOSS**