

SLICER

SL-20

AUDIO PATTERN PROCESSOR

Owner's Manual

Thank you, and congratulations on your choice of the BOSS SL-20 Audio Pattern Processor. Before using this unit, carefully read the sections entitled: "USING THE UNIT SAFELY" and "IMPORTANT NOTES" (separate sheet).

These sections provide important information concerning the proper operation of the unit. Additionally, in order to feel assured that you have gained a good understanding of every feature provided by your new unit, this manual should be read in its entirety. The manual should be saved and kept on hand as a convenient reference.

Main Features

- Continuously cuts input audio sounds and create a wide variety of slice patterns.
- Includes a "HARMONIC" slice pattern that produces melodies from the chords you play. This feature provides you with a new way to express your musical ideas.
- Includes a recording function. You can record up to forty seconds of the phrases you play, then play these back with loop playback. This lets you enjoy performing solos backed by your recorded phrases.
- The SL-20 is equipped with a MIDI IN connector, allowing you to synchronize tempos with external MIDI devices.
- The unit provides six different types of stereo effects, including three-dimensional sound field effects, which are available when the SL-20 is used in stereo output.
- An expression pedal (optional) can be connected and used for hands-free control of the direct level, effects level, and other parameters.
- The TEMPO indicator provides a clear confirmation of the current tempo, even on dimly lit stages.

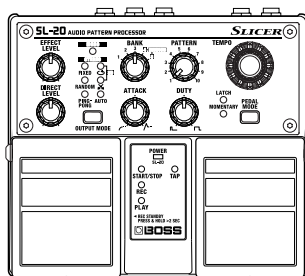

Copyright © 2008 BOSS CORPORATION

All rights reserved. No part of this publication may be reproduced in any form without the written permission of BOSS CORPORATION.

 **BOSS**®

Contents

Main Features	1	Using the TAP Pedal to Cue the Slice Pattern	12
Panel Descriptions	3	Setting the Tempo with the TAP Pedal	12
Front Panel	3	Recording/Loop Playback	13
Rear Panel	5	Controlling Functions with an Expression Pedal	15
Installing Batteries.....	6	Setting the Function of the Expression Pedal	15
Making the Connections	7	Setting the Tempo Response When Slice Patterns Are Switched	16
Mono Input Connection.....	8	Setting the Output Mode.....	17
Stereo Input Connection	9	Synchronizing Performances with External MIDI Devices	18
Operating the SL-20	10	Setting the Retrigger Mode.....	19
Basic Operation	10	Returning Settings to Their Factory Defaults.....	20
Panel Operation.....	11	Troubleshooting.....	21
Setting the Tempo.....	11	Setting Memo	22
Switching the Slice Pattern.....	11	Main Specifications	24
Adjusting the Attack and Duty....	11	MEMO	25
Adjusting the Effect Level	11		
Adjusting the Direct Level.....	11		
Switching the Output Mode.....	11		
Switching the Pedal Mode.....	11		

Printing Conventions and icons in This Manual

NOTE	Indicates information that you should be aware of when using the SL-20.
MEMO	Indicates supplementary information about an operation.
TIP	Indicates information about a convenient operation.
 , (p.**)	Indicates a reference page.

Panel Descriptions

Front Panel

BANK Knob

Turn to switch the slice pattern variation.

PATTERN Knob

Turn to switch the slice pattern.

* *The slice pattern is composed of one measure.*

EFFECT LEVEL Knob

Adjusts the volume of the effect sound. The volume of the effect sound increases as the knob is turned to the right.

TEMPO Indicator

This flashes in sync with the tempo.

The indicator flashes red on the slice pattern's first beat and green on the second, third, and fourth beats.

TEMPO Knob

This sets the tempo. Turn the knob to the right to increase the tempo, and to the left to slow the tempo down.

You can adjust the tempo more precisely by turning the knob slowly.

* *You cannot set the tempo with the SL-20 while MIDI clock is being received.*

PEDAL MODE Button

This selects the behavior of the START/STOP pedal when it's pressed.

LATCH: Pressing the START/STOP pedal toggles the effect on/off.

* *When switching effects off, the effect switches off at the time the pedal is released.*

MOMENTARY: The effect is switched on only as long as the START/STOP pedal is held down. Releasing the pedal switches off the effect.

DUTY Knob

Adjusts the duration of the slice pattern sound. The sound is played longer the further the knob is turned to the right.

DIRECT LEVEL Knob

Adjusts the volume of the direct sound when the effect is on. The volume of the direct sound increases as the knob is turned to the right.

ATTACK Knob

Adjusts the volume of the slice pattern's attack.

The volume of the attack is boosted as the knob is turned to the right.

OUTPUT MODE Button

This switches the output mode.

* *You can select the output mode only when connected for stereo output. MONO is selected when the SL-20 is connected in monaural.*

OUTPUT MODE List

OUTPUT MODE		Function
MONO		The same signal is output from both the OUTPUT R/MONO jack and the L jack.
STEREO	FIXED	Output with fixed left and right positions.
	RANDOM	The output randomly alternates between left, right, and center.
	PING-PONG	The output bounces between the left and right channels.
	AUTO	The location of the sound shifts smoothly between the left and right channels.
	⌘ (3D Cross)	The location of the sound moves forward and back as well as left and right.
	↻ (3D Panner)	This produces a swirling, three-dimensional type of sound.

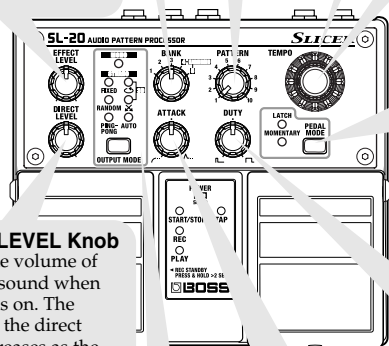

POWER Indicator

This indicator shows whether the power is on or off, and also functions as a battery-check indicator.

- * When the indicator starts to dim or fails to light, the batteries are exhausted. When this occurs, install new batteries. For instructions on replacing the batteries, refer to “Installing Batteries” (p. 6).
- * The power comes on when a plug is inserted into the INPUT R/MONO jack, and goes off when it is unplugged.

TAP Indicator

This lights up when the TAP pedal is pressed.

START/STOP Indicator

This lights up when the effect is on.

REC Indicator

This flashes when the SL-20 is in recording standby and lights steadily during recording.

PLAY Indicator

This lights up during loop playback of phrases.

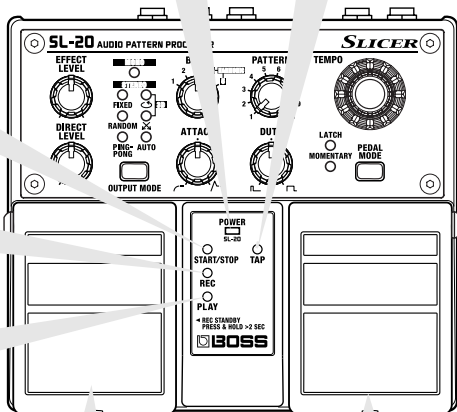

START/STOP Pedal

This alternately switches the effect on or off each time the pedal is pressed. The slice pattern plays when the effect is switched on.

Pressing and holding down the pedal for at least two seconds switches the SL-20 to recording standby. After recording, the SL-20 switches to loop playback.

🔊 “Recording/Loop Playback” (p. 13)

- * When switching effects off, the effect switches off at the time the pedal is released.
- * When the effects are off, sound arriving at the INPUT jack is output without change.

TAP Pedal

You can set the tempo by tapping it in with this pedal.

You can jump back to the beginning of the slice pattern measure by pressing the TAP pedal while the TAP indicator is off. When this is pressed during playback of a slice pattern or phrase, the SL-20 returns the slice pattern or phrase to the beginning and starts playback from there.

* You cannot set the tempo with the SL-20 while MIDI clock is being received.

- 🔊 “Using the TAP Pedal to Cue the Slice Pattern” (p. 12)
- 🔊 “Setting the Tempo with the TAP Pedal” (p. 12)
- 🔊 “Recording/Loop Playback” (p. 13)

Rear Panel

INPUT Jacks (INPUT R/MONO, L)

These input jacks are used for connecting electric guitars, bass guitars, other instruments, and effects processors. If using monaural input, connect only to the R/MONO jack.

- 🔗 “Making the Connections” (p. 7)
- * The INPUT R/MONO jack also doubles as the power switch. The power comes on when a plug is inserted into the INPUT R/MONO jack, and goes off when it is unplugged. Unplug any connected plugs when the unit is not in use.

EXP Pedal Jack

Connect an optional expression pedal (such as the Roland EV-5; optional) to this jack. Once connected, the pedal can be used to control the direct level and effect level in real time.

- * Use only the specified expression pedal (such as the Roland EV-5; optional). By connecting any other expression pedals, you risk causing malfunction and/or damage to the unit.

🔗 “Controlling Functions with an Expression Pedal” (p. 15)

DC IN (AC Adaptor) Jack

This jack is for connecting an AC adaptor (BOSS PSA series; optional).

Using an AC adaptor allows for long performances without worrying about the batteries going dead.

- * When you are using an AC adaptor, be sure to use only the specified type (PSA series; optional). Using an adaptor other than the specified type may cause the unit to malfunction, or cause damage to the unit.

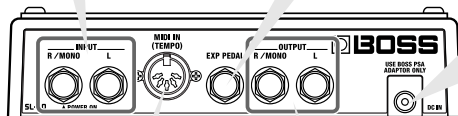

MIDI IN Connector

This connector receives the MIDI clock from a connected external MIDI device to synchronize the devices' tempos.

- 🔗 “Synchronizing Performances with External MIDI Devices” (p. 18)

OUTPUT Jacks (OUTPUT R/MONO, L)

Use these jacks to connect the SL-20 to a guitar amp, a keyboard amp, or to an effects processor, mixer, multitrack recorder, or other such device.

Connecting to both the R/MONO and L jacks allows you to achieve a variety of stereo effects. If using monaural output, connect only to the R/MONO jack.

- 🔗 “OUTPUT MODE Button” (p. 3)
- 🔗 “Making the Connections” (p. 7)
- 🔗 “Setting the Output Mode” (p. 17)

Installing Batteries

Insert the batteries as shown below, being careful to orient the batteries correctly.

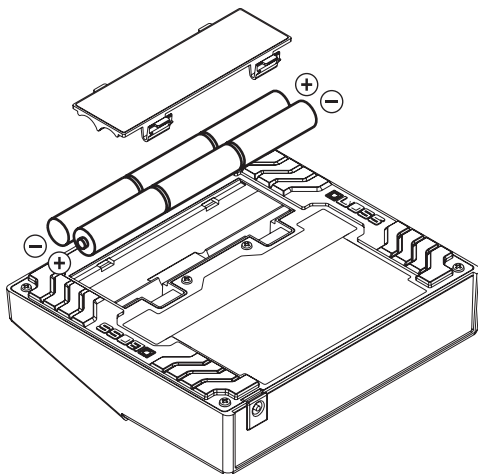

NOTE

- When turning the unit upside-down, get a bunch of newspapers or magazines, and place them under the four corners or at both ends to prevent damage to the buttons and knobs. Also, you should try to orient the unit so that no buttons or knobs get damaged.
- When turning the unit upside-down, handle it with care to avoid dropping it, or allowing it to fall or tip over.
- Make sure the “+” and “-” ends of the batteries are oriented correctly.
- Batteries are supplied with the unit. The life of these batteries may be limited, however, since their primary purpose is to enable testing.
- When the batteries run down, the POWER indicator grows dim. If this happens, install new batteries.
- When replacing the batteries, use six AA-type batteries.
- Avoid using new batteries together with used ones. In addition, avoid mixing different types of batteries. Doing so may result in fluid leakage that can damage the unit.
- Battery life can vary depending on the battery type.

MEMO

Continuous usage time under battery power is about 18 hours with alkaline batteries and about 7 hours with carbon batteries. (This may vary according to usage conditions.)

Making the Connections

NOTE

- When using an AC adaptor, be sure to use only the specified type (PSA series; optional). Using an adaptor other than the specified type may cause the unit to malfunction, or cause damage to the unit.
- To prevent malfunction and/or damage to speakers or other devices, always turn down the volume and turn off the power to all devices before making any connections.
- Noise may be produced if wireless communications devices, such as cell phones, are operated in the vicinity of this unit. Such noise could occur when receiving or initiating a call, or while conversing. Should you experience such problems, you should relocate such wireless devices so they are at a greater distance from this unit, or switch them off.
- Some connection cables contain resistors. When connection cables with resistors are used, the sound level may be extremely low, or impossible to hear. For information on cable specifications, contact the manufacturer of the cable.
- The INPUT R/MONO jack doubles as a power switch. Inserting a plug in the INPUT R/MONO jack turns on the power; the power is switched off when the plug is disconnected. Be sure to unplug the cable from this jack when the SL-20 is not in use.
- If there are batteries in the unit while an AC adaptor is being used, normal operation will continue should the line voltage be interrupted (such as from a power blackout or power cord disconnection).
- Once the connections have been completed, turn on power to your various devices in the order specified. By turning on devices in the wrong order, you risk causing malfunction and/or damage to speakers and other devices.
When powering up: Turn on the power to your guitar amp **last**.
When powering down: Turn off the power to your guitar amp **first**.
- Always make sure to have the volume level turned down before switching on power. Even with the volume all the way down, you may still hear some sound when the power is switched on, but this is normal, and does not indicate a malfunction.
- When operating on battery power only, the POWER indicator will become dim when battery power gets too low. Replace the batteries as soon as possible.
- This unit is equipped with a protection circuit. A brief interval (a few seconds) after power-up is required before the unit will operate normally.

Mono Input Connection

■ Guitar or Bass

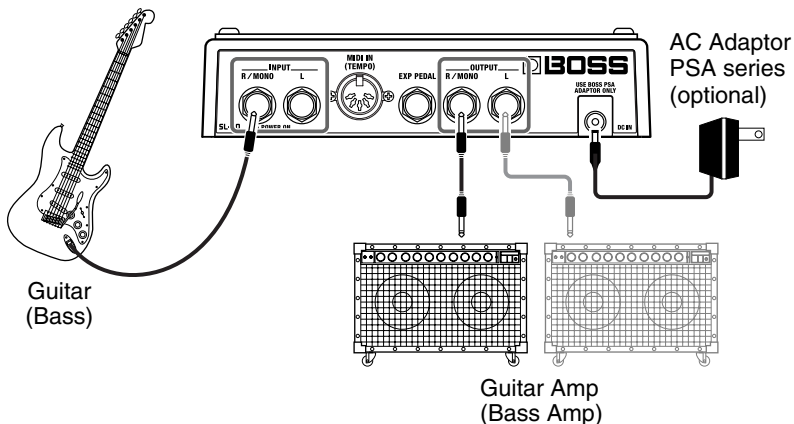

TIP

This works well when used in combination with distortion and modulation effects processors.

■ Keyboard

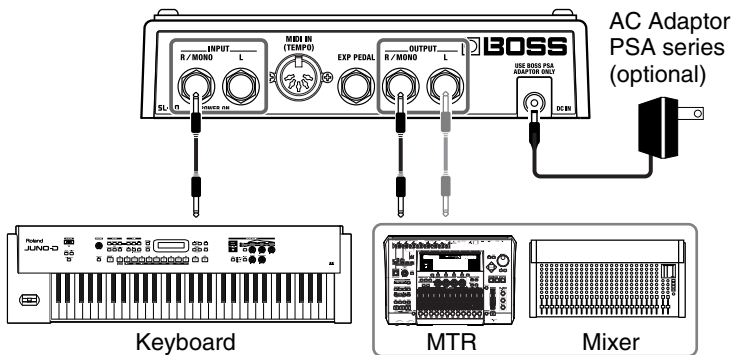

Stereo Input Connection

■ Guitar or Bass

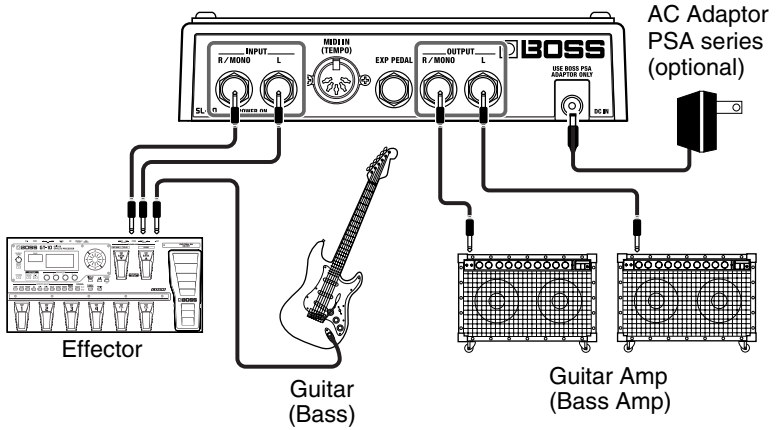

■ Keyboard

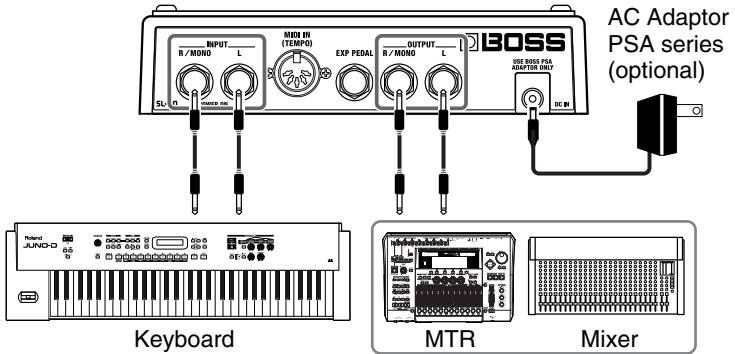

Operating the SL-20

Basic Operation

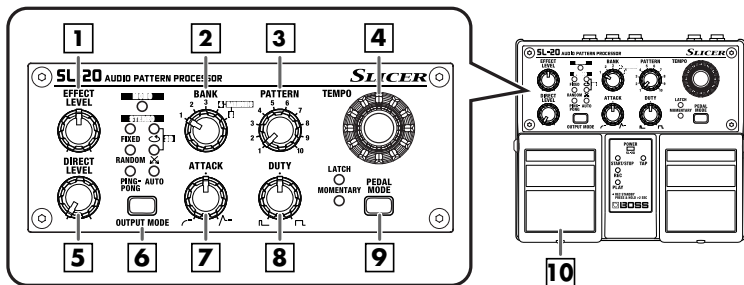

1. Set the knobs as shown in the figure above.
2. Press the START/STOP pedal **10** to switch the effect on (the START/STOP indicator lights).
3. Turn the EFFECT LEVEL knob **1** to adjust the volume of the effect.
4. Turn the TEMPO knob **4** to adjust the tempo.
** You cannot set the tempo with the SL-20 while MIDI clock is being received.*
5. Turn the ATTACK knob **7** to adjust the volume of the attack level.
6. Turn the DUTY knob **8** to adjust the length of time the sound plays.
7. Turn the DIRECT LEVEL knob **5** to adjust the volume of the direct sound when the effect is on.
8. Use the OUTPUT MODE button **6** to set the output mode.
** You can set the output mode only when the SL-20 is connected for stereo output. MONO mode is selected when the SL-20 connected for monaural output. For more detailed information about the output mode, refer to "OUTPUT MODE Button" (p. 3).*
9. Turn the BANK knob **2** to change the slice pattern variation.
10. Turn the PATTERN knob **3** to switch the slice pattern.
** You can set the action performed when slice patterns are switched. For details, refer to "Setting the Tempo Response When Slice Patterns Are Switched" (p. 16).*
11. Use the PEDAL MODE button **9** to set the function that the START/STOP pedal executes when it's pressed.
** For more detailed information about the pedal mode, refer to "PEDAL MODE Button" (p. 3).*

Panel Operation

Setting the Tempo

Turn the TEMPO knob **4** to the right to increase the tempo; to slow the tempo down, turn the knob to the left.

You can adjust the tempo more precisely by turning the knob slowly.

- * *The tempo setting is stored in memory.*
- * *You cannot set the tempo with the SL-20 while MIDI clock is being received.*

Switching the Slice Pattern

Use the BANK knob **2** and PATTERN

knob **3** to switch slice patterns.

The HARMONIC (BANK knob positions 4 and 5) contains slice patterns with melodic content.

Adjusting the Attack and Duty

To increase the volume of the attack, turn the ATTACK knob **7** to the right.

To increase the length of the sound, turn the DUTY knob **8** to the right.

Adjusting the Effect Level

Use the EFFECT LEVEL knob **1** to adjust the volume levels of the effect sound.

Adjusting the Direct Level

Use the DIRECT LEVEL knob **5** to adjust the volume levels of the direct sound when the effect is on.

Switching the Output Mode

Use the OUTPUT MODE button **6** to switch the output mode.

- * *You can select the output mode only when connected for stereo output. MONO is selected when the SL-20 is connected in monaural.*
- * *For more detailed information about the output mode, refer to "OUTPUT MODE Button" (p. 3).*

Switching the Pedal Mode

Use the PEDAL MODE button **9** to switch the pedal mode.

- * *For more detailed information about the pedal mode, refer to "PEDAL MODE Button" (p. 3).*

Using the TAP Pedal to Cue the Slice Pattern

You can jump back to the beginning of the current slice pattern by pressing the TAP pedal while the TAP indicator is off.

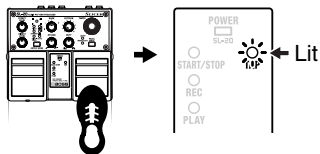

* The slice pattern is not played when the effect is switched off.

Setting the Tempo with the TAP Pedal

You can set the tempo for the slice pattern by pressing the TAP pedal in time with the tempo.

* You cannot set the tempo with the SL-20 while MIDI clock is being received.

1. Press the TAP pedal two or more times at the tempo you want to set.

This sets the tempo. The TEMPO indicator flashes in sync with the tempo.

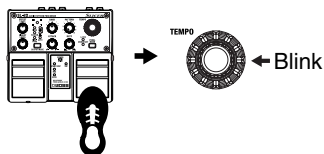

Press two or more times

* The tempo setting is stored in memory.

Recording/Loop Playback

The SL-20 lets you record up to forty seconds of sounds played with slice patterns.

After the recording is completed, loop playback of the sound begins. This allows you to perform with backing from the recorded sound.

- * You cannot record while the pedal mode (p. 3) is set to **MOMENTARY**.
- * Recorded phrase lengths are automatically adjusted to measure units.

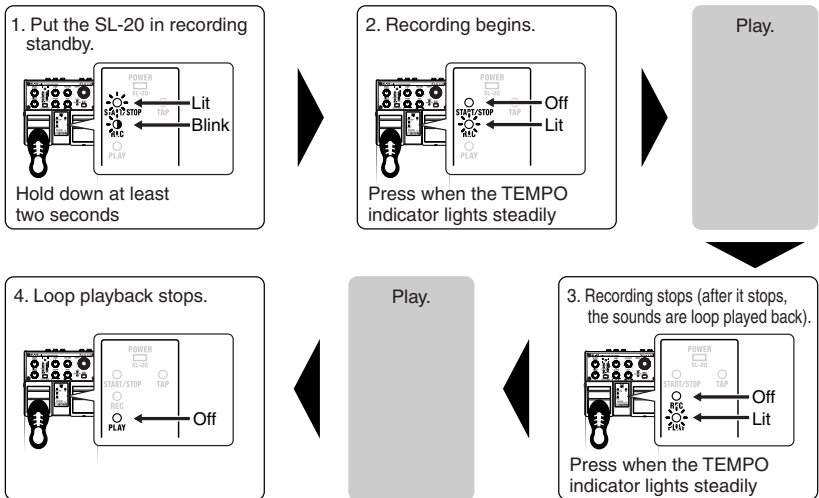

1. Press and hold down the START/STOP pedal for at least two seconds to put the SL-20 in recording standby mode.

The START/STOP indicator lights up, and the REC indicator starts flashing.

- * You can cancel the recording standby status by pressing and holding down the START/STOP pedal for at least two seconds while the SL-20 is in recording standby.

2. Press the START/STOP pedal to begin recording.

The START/STOP indicator goes out, and the REC indicator lights steadily, instead of flashing.

- * Recording begins from the start of the beat.

3. Press the START/STOP pedal to stop recording.

The PLAY indicator lights up; loop playback of the recorded phrase begins.

- * *Pressing the TAP pedal during loop playback of a phrase causes the SL-20 to return the phrase to the beginning and play it back from that point.*

TIP

You can enjoy performing solos using recorded phrases as backing sounds.

The volume level of the backing can be adjusted with the EFFECT LEVEL knob, while you can use the DIRECT LEVEL knob to adjust the volume of the solo performance.

4. Press the START/STOP pedal to stop loop playback.

The PLAY indicator goes out.

- * *Changing tempo by the SL-20 is not available while recording or loop playing back.*
- * *Recorded phrases cannot be permanently stored onboard the SL-20. Loop playback stops, and the recorded phrase is deleted.*
- * *You cannot change the tempo of the recorded phrases.*
- * *This feature does not permit overdubbing.*

Controlling Functions with an Expression Pedal

You can connect an expression pedal (such as the Roland EV-5; optional) to the EXP jack and use the pedal to control a variety of functions.

Function	Explanation
Direct Level	Controls the volume of the direct sound when the effect is on.
Effect Level	Controls the volume of the effect sound.
Output Level	Controls the output level when the effect is on.
Attack	Controls the volume of the attack.
Duty	Controls the duration of the sound.

- * With the Direct Level, Effect Level, Attack, and Duty functions, moving the pedal all the way back to the heel position sets the minimum value; moving the pedal all the way forward to the toe position sets the value to the current setting of the corresponding front-panel knob.
- * Set the minimum volume for the connected expression pedal to the “0” position.

Setting the Function of the Expression Pedal

1. While holding down the TAP pedal, connect the expression pedal.

The TAP indicator flashes.

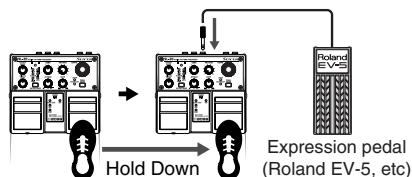

2. After confirming that the TAP indicator has flashed, release the TAP pedal.
3. Select the desired expression pedal function with the PATTERN knob.

PATTERN	Function
1	Direct Level
2	Effect Level
3	Output Level
4	Attack
5	Duty

4. Press the TAP pedal.

The TAP indicator flashes rapidly, and the setting is saved to the SL-20's memory.

- * Be sure not to turn off the power while the TAP indicator is flashing rapidly.
- * This setting remains stored even after the power is turned off.
- * The factory default setting for the expression pedal function is Direct Level.

Setting the Tempo Response When Slice Patterns Are Switched

When switching slice patterns, you can have all the patterns play at a set tempo, without the tempos switching to the ones set in each individual pattern.

- 1. While holding down the PEDAL MODE button, turn on the power to the SL-20.**
The upper part of the TEMPO indicator lights in green.

* *Plugging into the INPUT R/MONO jack switches on the power.*

- 2. When the TEMPO indicator starts flashing, release the PEDAL MODE button.**
- 3. Use the PATTERN knob to select the method used for setting the slice patterns.**

PATTERN	Explanation
1	Each time the slice patterns are switched, the tempo changes to that of the pattern you are switching to. When the slice pattern is switched, playback of the new pattern begins immediately.
2	The tempo does not switch when the slice patterns are switched. When a new slice pattern is selected, the current slice pattern plays to its end, after which the new slice pattern starts playing.

- 4. Press the PEDAL MODE button.**

The TEMPO indicator flashes three times, and the setting is saved to the SL-20's internal memory.

Once the setting is saved, and the SL-20 returns to its normal operating status.

* *Be sure not to turn off the power while the TEMPO indicator is flashing.*

* *This setting remains stored even after the power is turned off.*

* *The factory default setting for this action is PATTERN 1.*

Setting the Output Mode

You can have the output mode stereo effect (p. 3) applied to the direct sound when the effect is switched on.

1. While holding down the PEDAL MODE button, turn on the power to the SL-20.

The upper part of the TEMPO indicator lights in green.

* *Plugging into the INPUT R/MONO jack switches on the power.*

2. When the TEMPO indicator starts flashing, release the PEDAL MODE button.

3. Use the PATTERN knob to set the output mode.

PATTERN	Explanation
3	The stereo effect is applied to the direct sound.
4	The stereo effect is not applied to the direct sound.

4. Press the PEDAL MODE button.

The TEMPO indicator flashes three times, and the setting is saved to the SL-20's internal memory.

Once the setting is saved, and the SL-20 returns to its normal operating status.

* *Be sure not to turn off the power while the TEMPO indicator is flashing.*

* *This setting remains stored even after the power is turned off.*

* *The factory default setting for this action is PATTERN 3.*

Synchronizing Performances with External MIDI Devices

MIDI (Musical Instrument Digital Interface) is a universal standard that allows for the exchange of performance data and other information among electronic musical instruments and computers. Once MIDI cables are used to connect together devices equipped with MIDI connectors, each device can send data to, or receive data from any of the others. You can synchronize the SL-20 with performances played on an external MIDI device.

Data Synchronized with the SL-20

The following MIDI messages are handled during synchronization with the SL-20.

- Timing Clock
- Start
- Continue

Timing Clock corresponding to the tempo is transmitted from the master device (external MIDI device). The slave device (SL-20) synchronizes its performance to the transmitted Timing Clock. Start and Continue MIDI messages are also transmitted when these operations are carried out with the master device (external MIDI device).

Upon receiving the Start message from the external MIDI device, the SL-20 starts its slice pattern from the top. Upon receiving the Continue message, the SL-20 continues to playback from the current position in sync with the external MIDI device.

- * For more information on the MIDI messages handled by the devices you are connecting, refer to the owner's manual for each device.

1. Connect the external device to the MIDI IN connector.

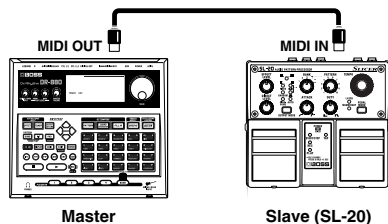

2. Transmit the MIDI messages from the external MIDI device.

The SL-20's performance is synchronized according to the MIDI messages from the external MIDI device.

- * You cannot set the tempo with the SL-20 while MIDI clock is being received.
- * In some cases, when the SL-20 receives the MIDI Clock and synchronization of the performance begins, the SL-20 may pause for several seconds. Afterwards, the performance is synchronized to the transmitted Timing Clock.
- * If the MIDI cable is disconnected during a synchronized performance, the SL-20's performance stops playing. Approximately one second after that, the slice pattern begins playing at the SL-20's internal tempo setting.

Setting the Retrigger Mode

The Retrigger Mode setting determines whether or not the slice pattern will be cued to the beginning when the START/STOP pedal is pressed during reception of MIDI Clock.

1. While holding down the PEDAL MODE button, turn on the power to the SL-20.

The upper part of the TEMPO indicator lights in green.

* *Plugging into the INPUT R/MONO jack switches on the power.*

2. When the TEMPO indicator starts flashing, release the PEDAL MODE button.

3. Use the PATTERN knob to set the retrigger mode.

PATTERN	Retrigger Mode	Explanation
5	Off	The slice pattern won't be cued to the beginning when the START/STOP pedal is pressed.
6	On	Pressing the START/STOP pedal cues the slice pattern to the beginning.

4. Press the PEDAL MODE button.

The TEMPO indicator flashes three times, and the setting is saved to the SL-20's internal memory.

Once the setting is saved, and the SL-20 returns to its normal operating status.

* *Be sure not to turn off the power while the TEMPO indicator is flashing.*

* *This setting remains stored even after the power is turned off.*

* *With the factory default settings, Retrigger Mode is set to Off.*

Returning Settings to Their Factory Defaults

You can return the following settings to their original factory defaults.

- Slice Pattern tempos
 - Expression Pedal Function setting (p. 15)
 - The tempo response when slice patterns are switched (p. 16)
 - Output Mode setting (p. 17)
 - Retrigger Mode setting (p. 19)
- * *Carrying out the following procedure completely clears the content currently stored in the memory.*

1. Switch off the power.

2. While holding down the OUTPUT MODE button, switch on the power.

The MONO indicator flashes.

* *Plugging into the INPUT R/MONO jack switches on the power.*

3. Press the OUTPUT MODE button.

The MONO indicator flashes rapidly, the setting is stored in memory and the unit returns to its normal state.

* *To cancel the setting change and the unit returns to its ordinary state, then before you press the OUTPUT MODE button, operate the START/STOP pedal or TAP pedal.*

* *Be sure not to turn off the power while the MONO indicator is flashing rapidly.*

Troubleshooting

Power doesn't come on

- Is the guitar or keyboard connected correctly to the INPUT R/MONO jack?
 - Check the connections again (p. 7–p.9).
 - * *The power will not turn on without a plug connected to the INPUT R/MONO jack.*
- Have the batteries run down?
 - Replace them with new batteries (p. 6).
 - * *The batteries included with the SL-20 are meant only to confirm that the unit is functional at the factory.*
 - * *To reduce batteries consumption, be sure to disconnect the plug connected to the INPUT R/MONO jack whenever the unit is not in use.*
- Is the specified AC adaptor (PSA series; optional) connected correctly?
 - Check the connections again (p. 7–p.9).
 - Never use any AC adaptor other than the adaptor specified.

No sound/volume is low

- Is the other equipment connected correctly?
 - Check the connections again (p. 7–p.9).
- Is the volume turned down on the connected guitar, keyboard, effects processor, or other device?
 - Check the settings on the connected equipment (p. 7–p.9).
- Could the ATTACK knob or DUTY knob be turned down?
 - Use the ATTACK knob or DUTY knob to adjust the level.
- Could the connected expression pedal be in the raised position?
 - When the expression pedal's function is set to Direct Level, Effect Level, or Output Level the effect sound is not output unless the pedal toe is pressed down completely (p. 15).
- Have the batteries run down?
 - Replace them with new batteries (p. 6).
 - * *The batteries included with the SL-20 are meant only to confirm that the unit is functional at the factory.*

The POWER indicator has gone dim

- Is the specified adaptor (PSA series; optional) properly connected?
 - Check the connection once more (p. 7–p.9).
 - * *Never use any AC adaptor other than one specified for use with the SL-20.*
- Have the batteries run down?
 - Replace them with new batteries (p. 6).
 - * *When the indicator goes dim or no longer lights while the effect is on, it means that the batteries must be replaced.*
 - * *The batteries included with the SL-20 are meant only to confirm that the unit is functional at the factory.*

Sound is distorted

- Are the EFFECT LEVEL knob, DIRECT LEVEL knob, and ATTACK knob positioned correctly?
 - Sounds may become distorted when the knobs are at certain settings. Turn down the EFFECT LEVEL knob, DIRECT LEVEL knob, and ATTACK knob to an appropriate level. If in spite of these measures the sound is still distorted, lower the output level of the device connected to the INPUT jacks.

The volume level of the instrument connected to the INPUT jacks is too low

- Could you be using a connection cable that contains a resistor?
 - Use a connection cable that does not contain a resistor.

Cannot save recorded slice sound

- Recorded slice sounds cannot be saved in the SL-20's internal memory.

Unable to overdub

- You cannot overdub during recording.

Sounds input in stereo are output in mono

- In order to apply effects suitable for the pattern, some slice patterns mix the input, then output this in mono.

Unable to switch output mode

- The output mode setting is fixed at MONO when the output is connected in mono.

Setting Memo

.....
.....
.....
.....
.....

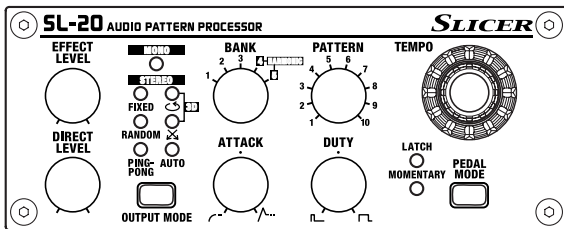

.....
.....
.....
.....
.....

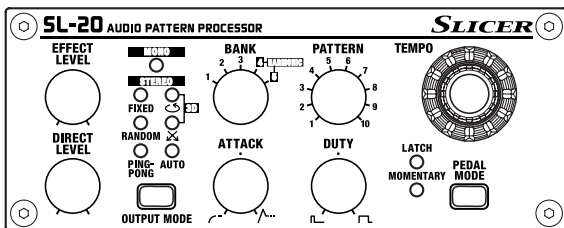

.....
.....
.....
.....
.....

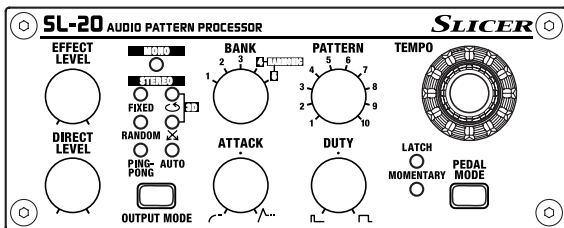

.....
.....
.....
.....
.....

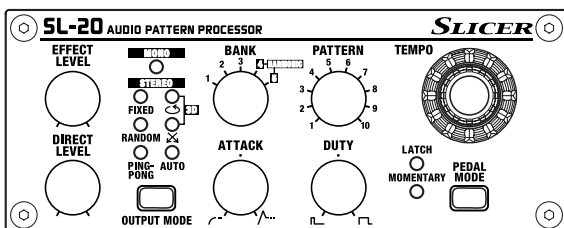

.....

.....

.....

.....

.....

.....

.....

.....

.....

.....

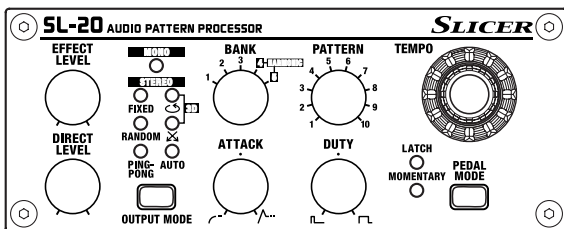

.....

.....

.....

.....

.....

.....

.....

.....

.....

.....

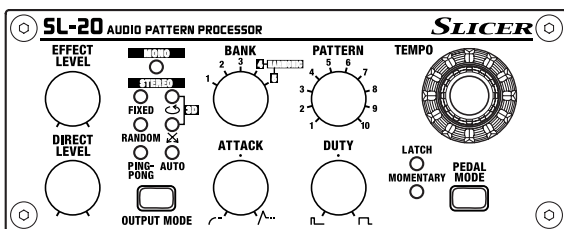

.....

.....

.....

.....

.....

.....

.....

.....

.....

.....

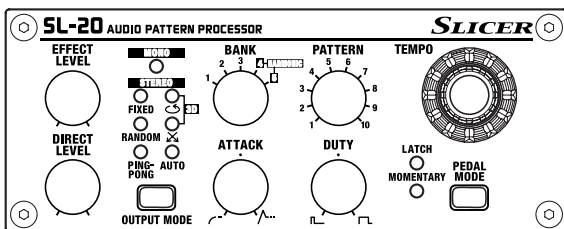

.....

.....

.....

.....

.....

.....

.....

.....

.....

.....

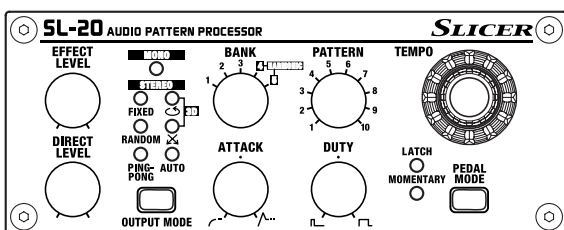

Main Specifications

SL-20: Audio Pattern Processor

Nominal Input Level

-20 dBu

Input Impedance

1 M Ω

Nominal Output Level

-20 dBu

Output Impedance

1 k Ω

Recommended Load Impedance

10 k Ω or greater

Tempo

30–250 bpm

Maximum Recording Time

40 seconds

Controls

START/STOP pedal

TAP pedal

EFFECT LEVEL knob

DIRECT LEVEL knob

BANK knob

PATTERN knob

ATTACK knob

DUTY knob

TEMPO knob

OUTPUT MODE button

PEDAL MODE button

Indicators

POWER indicator

(serves also as the battery check indicator)

START/STOP indicator

REC indicator

PLAY indicator

TAP indicator

MONO indicator

FIXED indicator

RANDOM indicator

PING-PONG indicator

AUTO indicator

3D PANNNER indicator

3D CROSS indicator

LATCH indicator

MOMENTARY indicator

TEMPO indicator

Connectors

INPUT jacks R/MONO, L (1/4 inch phone type)

OUTPUT jacks R/MONO, L (1/4 inch phone type)

EXP PEDAL jack (1/4 inch TRS phone type)

MIDI IN connector

DC IN jack (DC 9 V)

Power Supply

DC 9 V: Dry battery LR6/R6 (AA) type x 6, AC Adaptor (PSA series)

Current Draw

110 mA (9 V max.)

* *Expected battery life under continuous use:*

Carbon: 7 hours

Alkaline: 18 hours

These figures will vary depending on the actual conditions of use.

Dimensions

173 (W) x 158 (D) x 57 (H) mm

6-13/16 (W) x 6-1/4 (D) x 2-1/4 (H) inches

Weight

1.1 kg / 2 lbs 7 oz (including batteries)

Accessories

Owner's Manual

Leaflet ("USING THE UNIT SAFELY,"

"IMPORTANT NOTES," and "Information")

Dry battery R6 (AA) type (carbon) x 6

Options

AC Adaptor (PSA series)

Expression pedal (Roland EV-5)

* $0 \text{ dBu} = 0.775 \text{ Vrms}$

* *In the interest of product improvement, the specifications and/or appearance of this unit are subject to change without prior notice.*

MIDI Implementation Version: 1.00

1. Receive Data

■ System Real-Time Message

● Timing Clock Status F8H

● Start Status FAH

* *Upon receiving the Start (FAH), the slice pattern returns to the start of the pattern.*

● Continue Status FBH

* *Upon receiving the Continue (FBH), the SL-20 continues to playback in sync with the external MIDI device.*

For EU Countries



- UK** This symbol indicates that in EU countries, this product must be collected separately from household waste, as defined in each region. Products bearing this symbol must not be discarded together with household waste.
- DE** Dieses Symbol bedeutet, dass dieses Produkt in EU-Ländern getrennt vom Hausmüll gesammelt werden muss gemäß den regionalen Bestimmungen. Mit diesem Symbol gekennzeichnete Produkte dürfen nicht zusammen mit dem Hausmüll entsorgt werden.
- FR** Ce symbole indique que dans les pays de l'Union européenne, ce produit doit être collecté séparément des ordures ménagères selon les directives en vigueur dans chacun de ces pays. Les produits portant ce symbole ne doivent pas être mis au rebut avec les ordures ménagères.
- IT** Questo simbolo indica che nei paesi della Comunità europea questo prodotto deve essere smaltito separatamente dai normali rifiuti domestici, secondo la legislazione in vigore in ciascun paese. I prodotti che riportano questo simbolo non devono essere smaltiti insieme ai rifiuti domestici. Ai sensi dell'art. 13 del D.Lgs. 25 luglio 2005 n. 151.
- ES** Este símbolo indica que en los países de la Unión Europea este producto debe recogerse aparte de los residuos domésticos, tal como está regulado en cada zona. Los productos con este símbolo no se deben depositar con los residuos domésticos.
- PT** Este símbolo indica que nos países da UE, a recolha deste produto deverá ser feita separadamente do lixo doméstico, de acordo com os regulamentos de cada região. Os produtos que apresentem este símbolo não deverão ser eliminados juntamente com o lixo doméstico.
- NL** Dit symbool geeft aan dat in landen van de EU dit product gescheiden van huishoudelijk afval moet worden aangeboden, zoals bepaald per gemeente of regio. Producten die van dit symbool zijn voorzien, mogen niet samen met huishoudelijk afval worden verwijderd.
- DK** Dette symbol angiver, at i EU-lande skal dette produkt opsamles adskilt fra husholdningsaffald, som defineret i hver enkelt region. Produkter med dette symbol må ikke smides ud sammen med husholdningsaffald.
- NO** Dette symbolet indikerer at produktet må behandles som spesialavfall i EU-land, iht. til retningslinjer for den enkelte regionen, og ikke kastes sammen med vanlig husholdningsavfall. Produkter som er merket med dette symbolet, må ikke kastes sammen med vanlig husholdningsavfall.
- SE** Symbolen anger att i EU-länder måste den här produkten kasseras separat från hushållsavfall, i enlighet med varje regions bestämmelser. Produkter med den här symbolen får inte kasseras tillsammans med hushållsavfall.
- FI** Tämä merkintä ilmaisee, että tuote on EU-maissa kerättävä erillään kotitalousjätteistä kunkin alueen voimassa olevien määräysten mukaisesti. Tällä merkinnällä varustettuja tuotteita ei saa hävittää kotitalousjätteen mukana.
- HU** Ez a szimbólum azt jelenti, hogy az Európai Unióban ezt a terméket a háztartási hulladéktól elkülönítve, az adott régióban érvényes szabályozás szerint kell gyűjteni. Az ezzel a szimbóllumal ellátott termékeket nem szabad a háztartási hulladék közé dobni.
- PL** Symbol oznacza, że zgodnie z regulacjami w odpowiednim regionie, w krajach UE produktu nie należy wyzucać z odpadami domowymi. Produktów opatrzonych tym symbolem nie można utylizować razem z odpadami domowymi.
- CZ** Tento symbol udává, že v zemích EU musí být tento výrobek sbírán odděleně od domácího odpadu, jak je určeno pro každý region. Výrobky nesoucí tento symbol se nesmí vyhazovat spolu s domácím odpadem.
- SK** Tento symbol vyjadruje, že v krajinách EÚ sa musí zber tohto produktu vykonávať oddelene od domového odpadu, podľa nariadení platných v konkrétnej krajine. Produkty s týmto symbolom sa nesmú vyhazovať spolu s domovým odpadom.
- EE** See sümbol näitab, et EL-i maades tuleb see toode olemprügist eraldi koguda, nii nagu on igas piirkonnas määratletud. Selle sümboliga märgitud tooteid ei tohi ära visata koos olmeprügiga.
- LT** Šis simbolis rodo, kad ES šalyse šis produktas turi būti surenkamas atskirai nuo buitinių atliekų, kaip nustatyta kiekviename regione. Šiuo simboliu paženklinoti produktai neturi būti išmetami kartu su buitiniemis atliekomis.
- LV** Šis simbols norāda, ka ES valstīs šo produktu jāievāc atsevišķi no mājsaimniecības atkritumiem, kā noteikts katrā reģionā. Produkta ar šo simbolu nedrīkst izmest kopā ar mājsaimniecības atkritumiem.
- SI** Ta simbol označuje, da je treba proizvodov iz držav EU zbirati ločeno od gospodinskih odpadkov, tako kot je določeno v vsaki regiji. Proizvoda s tem znakom ni dovoljeno odlagati skupaj z gospodinskimi odpadki.
- GR** Το σύμβολο αυτό υποδηλώνει ότι στις χώρες της Ε.Ε. το συγκεκριμένο προϊόν πρέπει να συλλέγεται χωριστά από τα υπόλοιπα οικιακά απορρίμματα, σύμφωνα με όσα προβλέπονται σε κάθε περιοχή. Τα προϊόντα που φέρουν το συγκεκριμένο σύμβολο δεν πρέπει να απορρίπτονται μαζί με τα οικιακά απορρίμματα.



This product complies with the requirements of EMC Directive 2004/108/EC.

For EU Countries

FEDERAL COMMUNICATIONS COMMISSION RADIO FREQUENCY INTERFERENCE STATEMENT

This equipment has been tested and found to comply with the limits for a Class B digital device, pursuant to Part 15 of the FCC Rules. These limits are designed to provide reasonable protection against harmful interference in a residential installation. This equipment generates, uses, and can radiate radio frequency energy and, if not installed and used in accordance with the instructions, may cause harmful interference to radio communications. However, there is no guarantee that interference will not occur in a particular installation. If this equipment does cause harmful interference to radio or television reception, which can be determined by turning the equipment off and on, the user is encouraged to try to correct the interference by one or more of the following measures:

- Reorient or relocate the receiving antenna.
- Increase the separation between the equipment and receiver.
- Connect the equipment into an outlet on a circuit different from that to which the receiver is connected.
- Consult the dealer or an experienced radio/TV technician for help.

This device complies with Part 15 of the FCC Rules. Operation is subject to the following two conditions:

- (1) this device may not cause harmful interference, and
- (2) this device must accept any interference received, including interference that may cause undesired operation.

Unauthorized changes or modification to this system can void the users authority to operate this equipment.
This equipment requires shielded interface cables in order to meet FCC class B Limit.

For Canada

NOTICE

This Class B digital apparatus meets all requirements of the Canadian Interference-Causing Equipment Regulations.

AVIS

Cet appareil numérique de la classe B respecte toutes les exigences du Règlement sur le matériel brouilleur du Canada.

 **BOSS**[®]
BOSS Corporation



* G 6 0 2 7 1 3 1 - 0 1 *

G6027131R0 1RTC